

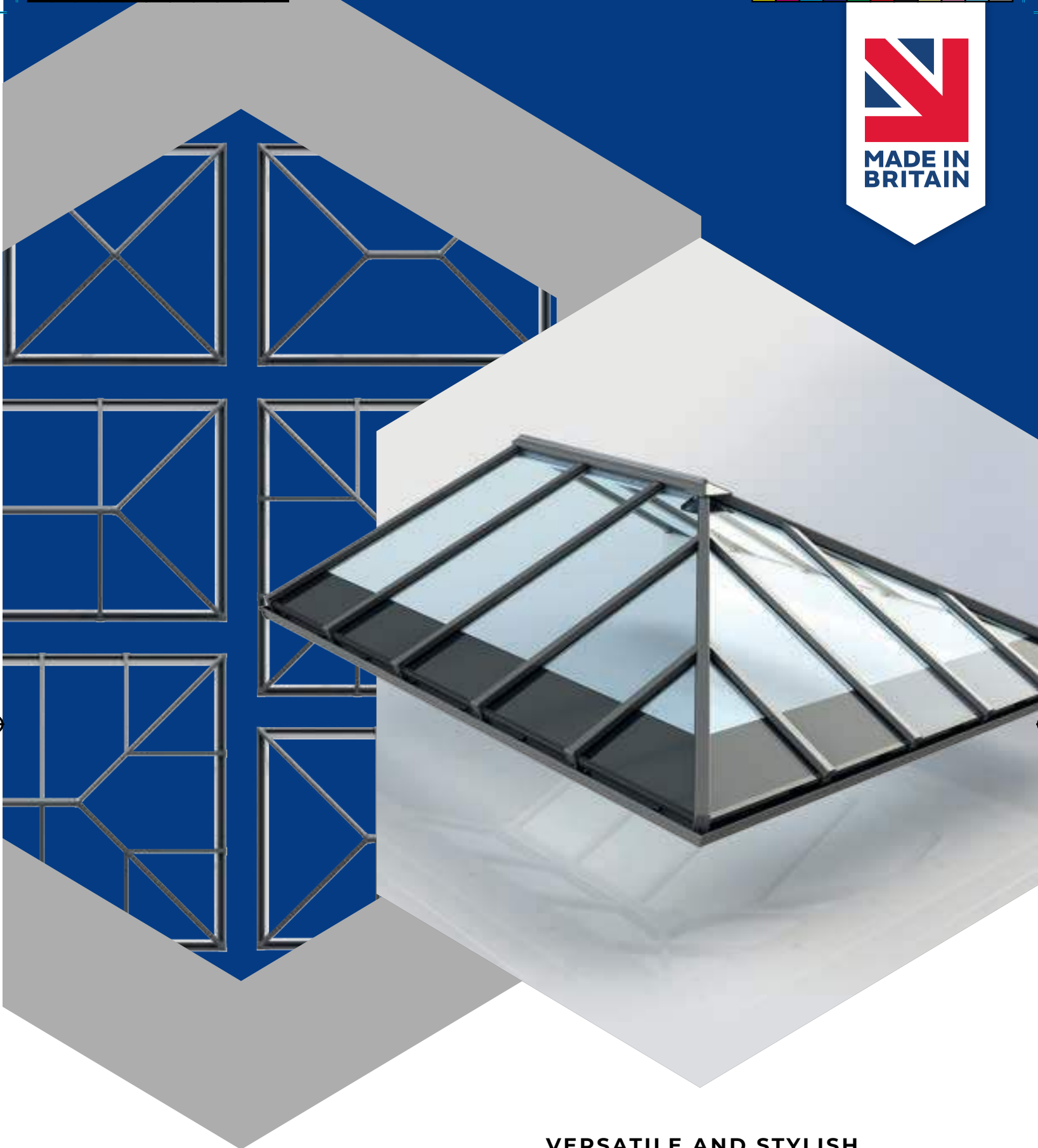

**MADE IN
BRITAIN**



**VERSATILE AND STYLISH
NEXT GENERATION ALUMINIUM
CONSERVATORY ROOF**



SupaLite

Transforming Living Spaces



Next generation conservatory
from the aluminium experts

Fabricator Direct

No conflict with the systems company

Modern Looks

Squared aesthetics offer a more up-to-date appearance

Stronger Design

Bigger spans are possible using standard parts

Thermally Broken

More thermally efficient - creating a key sales advantage

Versatile and stylish, S2 is based on the well proven and well respected K2 system, but benefits from over 2 years of additional development. Allowing installers and fabricators to differentiate their conservatory offering with a modern, easy-to-fit, thermally efficient product.

Wallcharts are available showing the full range of S2 conservatory components.



Versatile Design born from experience

S2 Systems can accommodate every style and combination of roof, new slimline appearance of the roof alongside customisable options such as variable internal pelmet and aluminium gutter shroud will add the finishing touches to any glazed extension.



Ultra-strong Box Gutter



Multi-chambered PVC-U cappings



Aluminium capping upgrade option

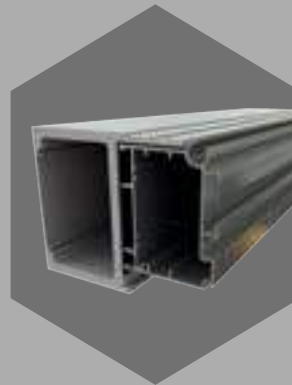

Eaves Beam Bolster to span large openings for bi-fold or patio doors

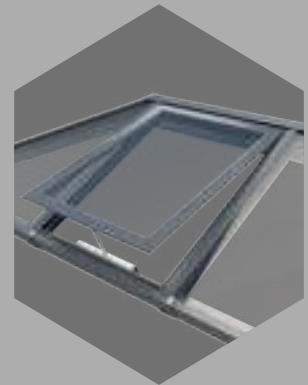

EXCLUSIVE Vent Option
SHEERVENT
FLUSH INTELLIGENT VENTILATION

2.5° - 37.5°
Versatile pitch range

25/35mm
Polycarbonate

24/36mm
Glass

 **Polypipe**

Uses the 'tried and tested' Polypipe Plus rainwater range

Available in:

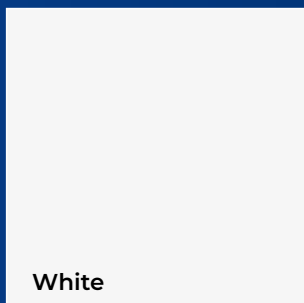

White

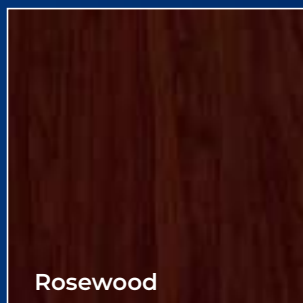

Rosewood



Grey Grained Foil



Bespoke RAL colours



The S2 aluminium conservatory roof delivers real benefits to homeowners in a system that is as installer friendly as the rest of the Sheerline range.

Next generation conservatory roof from the aluminium experts



- Georgian, Victorian and Lean-to styles can be combined with valleys and box gutters to form a variety of designs, which can be enhanced by incorporating the following:

3 and 5 facets, hipped and gable ends

- Intelligent system design and multi-million £ investment based on the proven and highly respected K2 roof system

- Multi-chambered PVC-U and thermally broken aluminium glazing bar options

- Full Aluminium roof options



3
stocked
colours
9
dual colour
combinations

+ Bespoke RAL colours

Designed, made and delivered by Sheerline

Manufactured in the UK, we design and make every major aluminium and moulded component ourselves for a resilient and reliable supply chain. This gives us the control to offer unbeatable and responsive service, helping keep lead-times agile and responsive.

Sustainably manufactured

All extruded aluminium and PVC-U components are manufactured at our highly integrated, ISO 9001 accredited facility in Derbyshire. Our SMS HYBEX press uses up to 55% less energy than traditional presses helping us lower the carbon footprint of the S2 system.

With a cutting edge, thermally efficient design, S2 brings Sheerline innovation to conservatory roofs for the first time.

Available exclusively through Prefix Systems® and SupaLite, two highly respected roof experts. S2 from Sheerline is the aluminium conservatory roof you've been waiting for.



Experienced Technical Support

S2 is supported by experienced technical experts who have a wealth of practical knowledge gained from designing and developing a range of conservatory systems. They are also the team that developed our award winning S1 roof lantern.



Powered by PST Software

Covering everything you need from design to quotation. PST is an advanced conservatory design software. Designed specifically for conservatory and orangery installers, Sheerline offers PST support via a former member of the PST team.

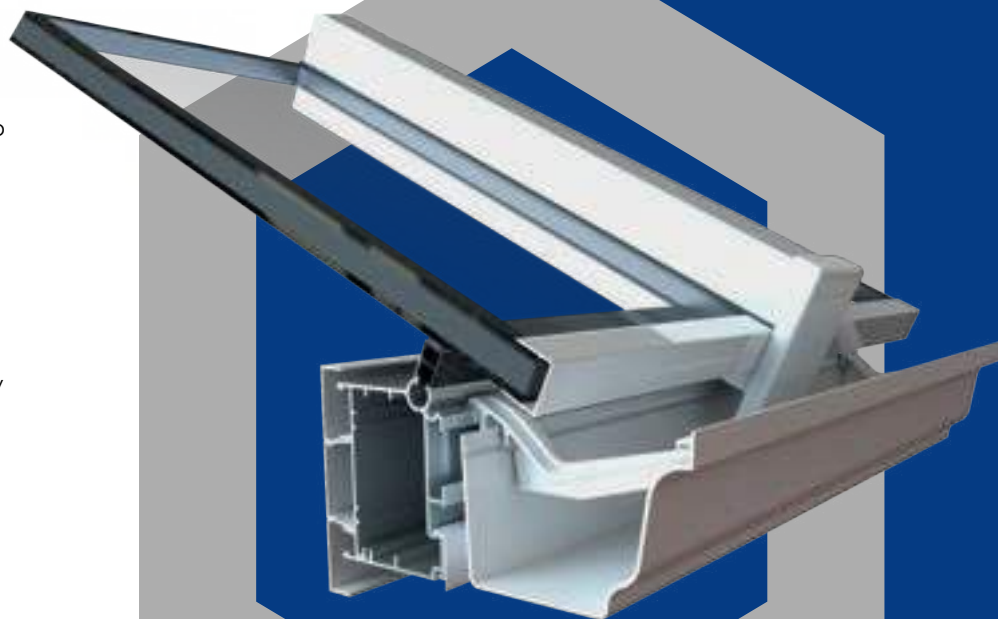

ROOF PITCHES

- Lean-to 2.5° - 30°
- Standard 17.5° - 37.5°

Gable, Georgian & Victorian

GLAZING OPTIONS

- 24/25mm glazing thickness in multi-walled polycarbonate or double glazed units.
- 35/36mm glazing thickness available.

Glazing Bars

Chambered PVC-U cappings are fitted as standard, offering improved thermal performance



Aluminium cappings are available for an ultra high-end finish



The glazing bars for the S2 system have been re-engineered with a modern and slimline look, but they do not compromise in either strength or appearance.

The S2 has been designed to cater for large projections associated with modern glazed extensions, but still maximising the glazed area within the structure. The S2 range of roofing bars will outperform the competition to create those grand designs, today's consumers desire.

Jack rafter

- Strong mechanical fixing
- Victorian and Georgian hip designed with a circular channel to accept a pivot bolt to allow for pitch variations
- Jack rafter arm with a unique glass paddle to prevent slippage of glazing into valley applications
- Stronger connection
- Jack rafter bolt encapsulated into bar



Bolster end cap - Standard



Bolster cover to eaves beam cover - Optional



Aluminium clad bolster bar detail

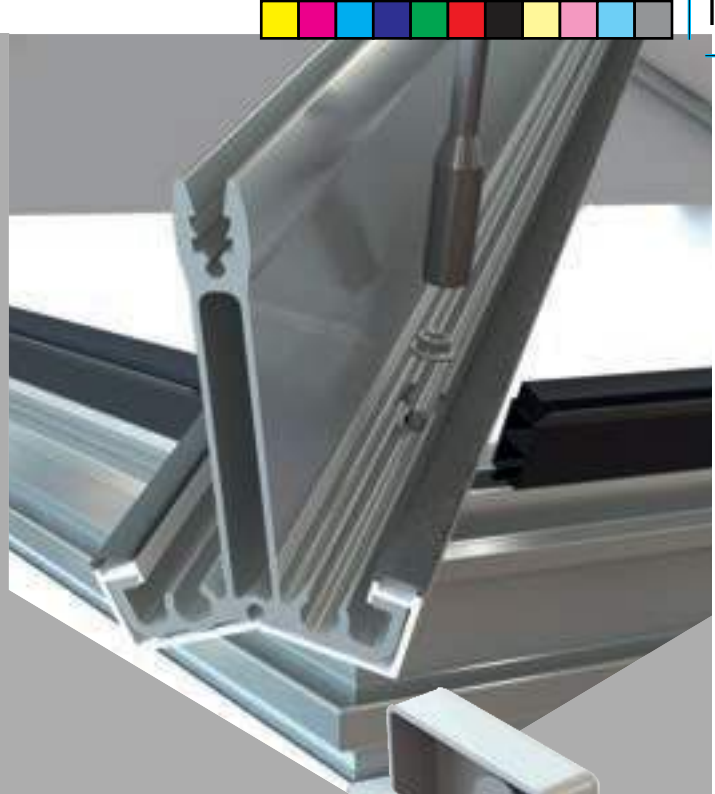

High precision end caps complete the distinctive modern aesthetics



Features

- Chambered PVC capping as standard
- Square contemporary internal and external cladding
- 24mm/36mm glass
- 25mm and 35mm polycarb options
- Square end caps
- Glazing security plates prevents glass slippage without reducing glass overhang
- Aluminium lean-to cloaking trim
- Internal bolster with modern aluminium cladding
- Range of glazing bar specification, from light through to heavy duty bolster
- Available in any RAL colour



Eaves Beam

Designed for greater spanning capability, the box eaves beam provides strength and stability where required whilst accommodating all design and style options. Perfect for meeting homeowner demand for wide panoramic doors incorporated into their conservatories.

Larger openings within extensions are now commonplace, bi-folding and sliding doors are the consumers preferred option and the S2 roof system has been engineered to ensure those designs can be accommodated with minimal fuss and at a cost-effective price.

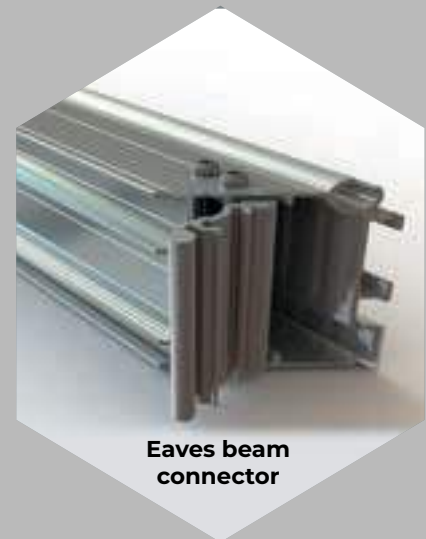

Designed with an inherently strong, closed box shape, S2's eaves beam provides a versatile base for a wide variety of conservatory styles.

Features

- Box section design for stability and strength
 - Circular channel to accept pivot bolt which allows for pitch variations
- Corner connector designed to provide a strong structural connection & able to accommodate any angle
 - Square design universal internal cover in PVC-U and aluminium options
- Multi-use internal cladding for various applications, i.e. eaves, ridge, valley for reduced stockholding
- Eaves beam combined with eaves beam gable adaptor to create a flat support for gable frames.

Low Pitch Eaves

Our reduced height eaves beam is 70mm in height for low pitch installations, providing an ideal cost effective solution when required.

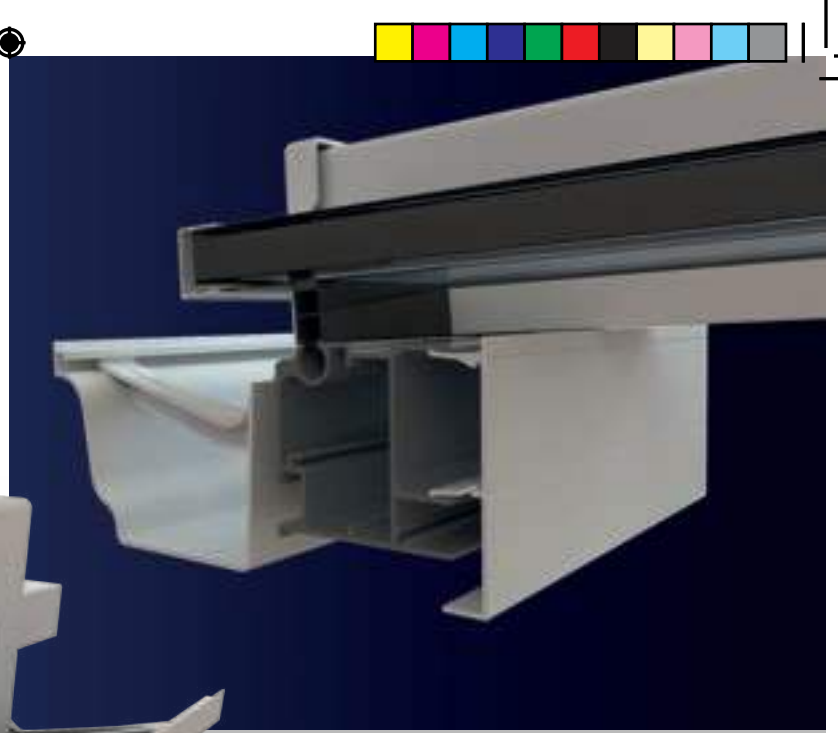

Eaves Beam Bolster

- For additional support over wider opening for bifold and sliding doors.
- Innovative design to sit over and behind the existing eaves beam
- Works seamlessly with rest of the S2 system including box gutters with no additional notching required
- Aluminium internal clip in cladding to match the existing eaves cladding
- Available in White, Rosewood and Grey
- Available in any RAL colour

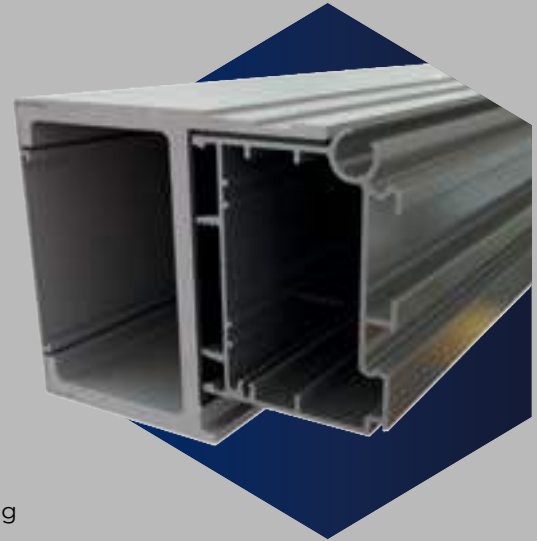

Standard eaves beam internal view

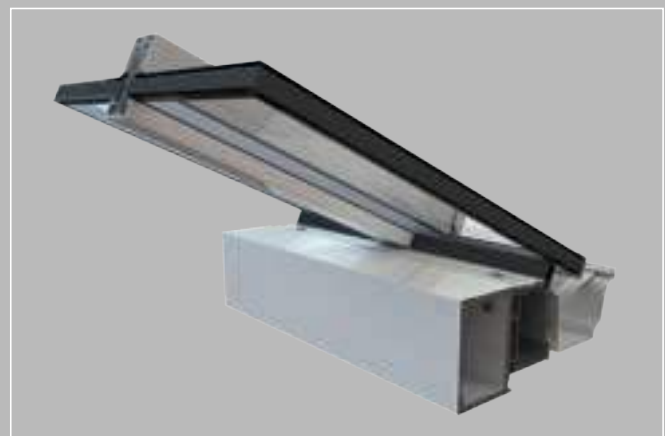

Bolstered eaves beam internal view



Gutter Shroud

The S2 gutter shroud has been designed to provide a premium 'orangery' style gutter line, whilst simple to install the shroud gives a stylish superior finish.

The perfect, properly proportioned solution for the markets growing demand for premium feeling living spaces. Creating Victorian inspired garden rooms with authentic period styling that add grandeur to a property.

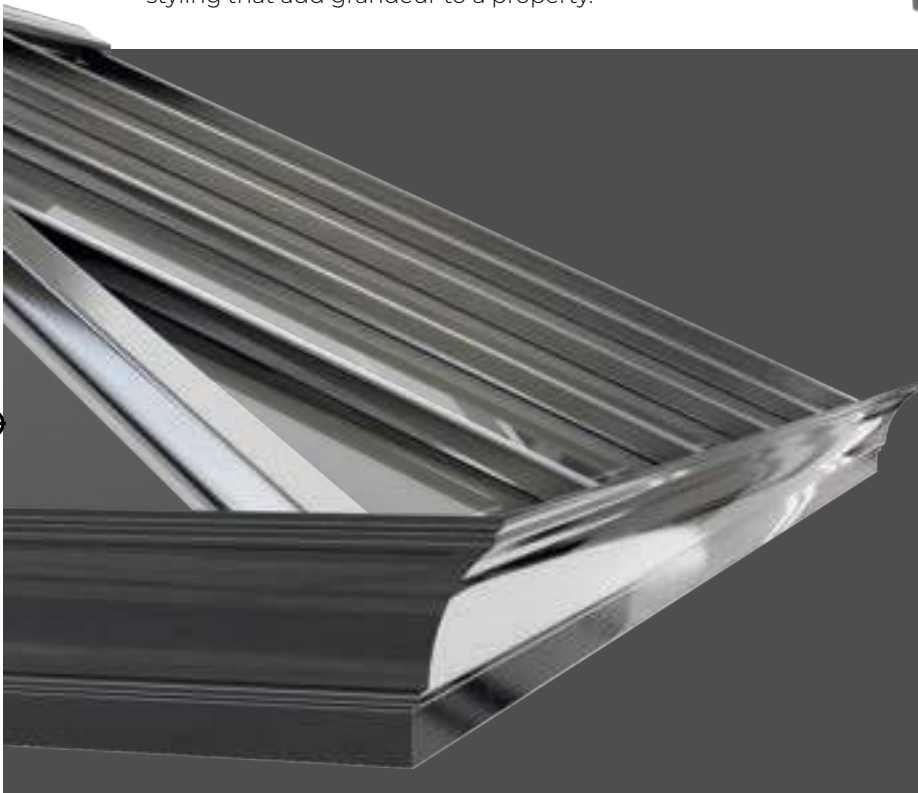

Features

- All aluminium 2 part design
- Powder coated finish
- No unsightly gutter wires or hanging brackets
- Zinc die cast gutter brackets support the gutter shroud from within
- Die cast corner and inline jointers for professional appearance
- Designed to provide stunning architectural detailing

RAL colours

Like the rest of the S2 conservatory roof system, the aluminium gutter shroud can be powder coated in any RAL colour.

The perfect way to meet the most exacting project's requirements and create a distinctive look that will complement any property.



Internal Pelmet

Create orangery style roofs with the S2 internal pelmet, this simple addition is a cost effective way to create an orangery feel but results in a premium look and feel. Combine this with the gutter shroud externally for a superior glazed extension.

- Ingenious, simple design which can be fabricated in house and adjusted on-site
- Quick to install
- Adaptable to all roof styles, designs and pitches
- Stunning finished detail



S2's internal pelmet is the perfect way to add perimeter lighting to a conservatory



Gutter

S2 has been engineered to accept the Polypipe Plus gutter range. This tried and tested system has an attractive ogee style face and is available in White, Black and Grey as standard.

- Ogee design
- Quick and easy to install
- Dedicated clip-on gutter bracket to suit eaves beam
- Integrates with gutter shroud
- Available in any RAL colour



S2 conservatory roof 11





Ridge and Wall Plates

The sleek yet strong S2 ridge system captures all the design principles of the new S2 roof. A low profile ridge capping ensures the top line of the ridge is clean and modern for the contemporary design, but this can be upgraded to a more traditional feel with a selection of cresting's and finials.

Ridges

- Slimline ridge system as standard
- Fixed and variable ridge options
- Square internal cladding for modern uncluttered aesthetics
- Utilises same internal cladding as eaves beam for matching cladding
- Low profile ridge option as standard
- Two styles of final & cresting available
- Available in PVC & full aluminium options
- Foam and brush weather seal
- Available in any RAL colour

Wallplates

- 2.5 degree wallplate for low pitch solutions
- Simple and easy to install, fixed 5-10° wall plate for standard lean-to and canopy roofs
- Variable wallplate for pitched range of 5-30°
- Variable wallplate with radius ends for hipped lean to applications
- PVC and aluminium cladding option
- Available in any RAL colour



Fixed wall plate



Variable wall plate 5° – 17.5°

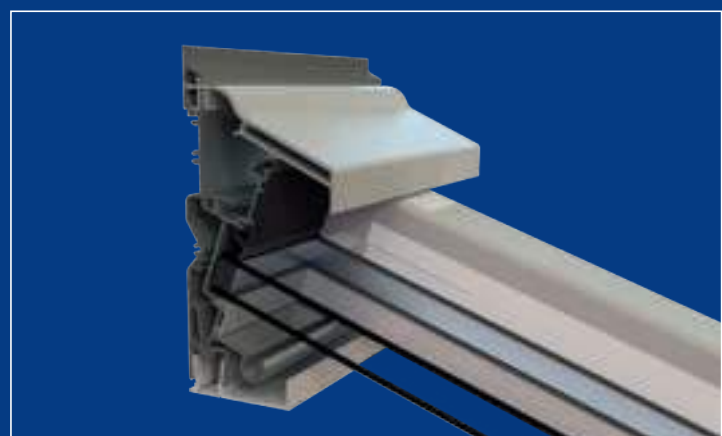

Variable wall plate 17.5° – 30°



Box Gutters

The S2 box gutter is class leading in terms of design and function. This high capacity box gutter has been designed to eliminate unsightly gallows brackets to support the box gutter meaning the gutter is simple yet highly effective.



- Self supporting box gutter with internal support brace – no need for gallows brackets
- High capacity
- Box gutter independent from eaves beam – no awkward mitres or notching
- Box gutter adaptors sit outbound, no chance of leaking joints

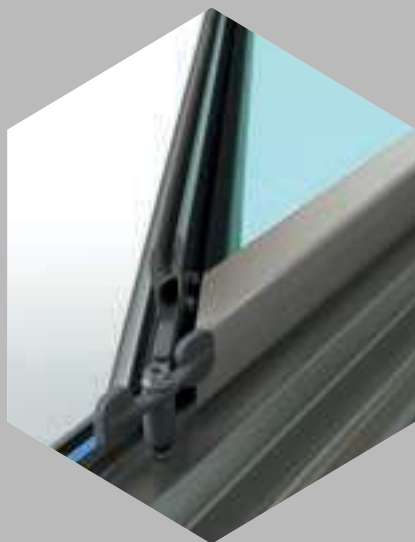

Valleys

Create valley gutter details with the S2 valley detail, commonly used on 'P' and 'T' shape roofs, the valley is fully adjustable to allow for multiple pitch variations.

3 key components mean this valley is simple to fabricate, but has been engineered to span greater lengths than ever before.

- Allows for wide pitch variations
- Utilises same internal cladding as eaves and ridge, creating seamless lines
- Contemporary design
- Robust powder coated aluminium valley centre



Tie Wires

In keeping with the S2 modern design principles, the system utilises a tie wire as standard for larger roofs.

The slimline cable is less intrusive to the eye, whilst still remaining effective in its performance. The unbroken span across the roof means no vertical tie rods that would interfere with fans or lights.





THE UK'S MOST SECURE, SUSTAINABLE AND STYLISH ROOF LANTERN



**WITH GREAT LOOKS FROM EVERY ANGLE –
DUE TO OUR UNIQUE ULTRA-LOW LINE AESTHETICS.**

Configurations: 13 different roof styles - including pyramids

SLIM SIGHTLINES

50MM

RAFTER, HIP, JACK
RAFTERS AND RIDGE

PITCH

FIXED

25°

MAXIMUM:

3.2 x 6M



Secured by Design



Official Police Security Initiative

UPGRADE OPTION
NOW AVAILABLE





SECURE



Features such as anti-tamper security screws, a patent pending glass lock and the fact that all top caps are protected by overlapping castings, protecting them from attack, make S1 one of the most secure lanterns available.

STYLISH



Clean lines and discrete external aesthetics create an exceptional looking roof with corner and rafter end caps that run perfectly parallel with the perimeter of the roof. While deep internal rafter and ridge bars create a high end architectural aesthetic.

SUSTAINABLE

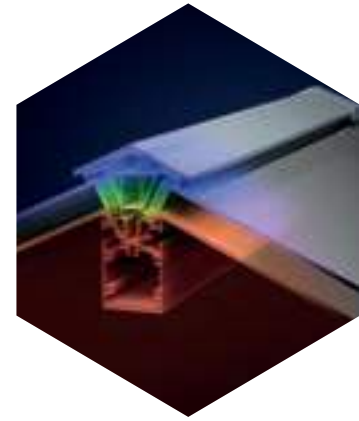

Thermlock® multi-chamber technology, far superior to traditional polyamide, helps make S1 the most thermally efficient lantern in its class. Inbuilt perimeter seals and a snow load rating of 1.2 KN/m² also ensures S1 is ready for the worst of British weather.

NEW 3 WAY OPTION

Adding three more styles to the S1 roof lantern, our new **3 Way option** allows for bigger spans to be catered for without the need for jack rafters.

All with the same sleek aesthetics as our existing 2 and 4 way designs.



FOR S1 LANTERNS AND S2 ROOFS WE ARE ALSO INTRODUCING

SHEERVENT[®] FLUSH INTELLIGENT VENTILATION

With a sleek minimalist design that sits perfectly flush with S1's rafter bars, and using powered actuators that can be intelligently automated, Sheerline has reimagined roof vents, bringing them into the 21st century at last. Dispensing with the need for muntin bars, SheerVent[®] offers reliable ventilation without the risk of leaks.

Fully thermally broken and using the same high-performance glazing as the rest of the S1 roof, SheerVent[®] is yet another feature that puts the S1 lantern ahead of the competition.



Manufactured and designed in the UK, innovative aluminium windows, doors and roofs with a unique approach to integrated systems design.



SupaLite
Transforming Living Spaces

System manufactured by



www.supaliteroof.co.uk ☎ 01772 828060 ✉ sales@supaliteroof.co.uk