

ELITIS[®]
SMART • EFFICIENT • SECURE

Windows & Doors

10
YEAR
GUARANTEE



Why Choose Elitis?

Expertly designed and manufactured in the UK, we deliver nothing less than the highest quality products all backed up by the longest guarantees in the industry.



Buy British

Made to the highest standards in our award winning workshops by British craftspeople.



Up to 10-years guarantee

Quality products with longest guarantee in the industry.



Up to A+ Energy Efficiency

Keep your home warmer and reduce your bills.



Protect your home

Use smart technology to alert you when your doors or windows are open or closed.



Colour match guarantee

We'll make your home have increased curb appeal with colour matched windows, doors and roofline.



Window made from other windows

Made from recycled content, with virgin white uPVC outer frame.

Contents

Why Choose Elitis®?	01	Elitis Doors	29
Secure Windows & Doors	03	Elitis Composite & Solid Core Doors	31
Our Gurarantee	05	Features & Benefits	33
Elitis Sustainability	07	Door Accessories	35
A+ Rated Windows - Lowering Bills	09	Elitis French Doors	37
Elitis Windows	12	Elitis Patio Doors	41
Window Styles & Layouts	13	Elitis Lift & Slide Patio Doors	43
Elitis Windows Hardware	17	Elitis Aluminium Heritage Doors	45
Elitis uPVC Windows	19	Elitis Aluminium Bi-fold Doors	47
Elitis Timber Alternative Windows	21	Roof Lanterns	53
Elitis Timber Manufacturing Techniques	23	Kubu Smart Security	55
Elitis Aluminium Windows	25	Elitis Colour Collection	57
		Security Comparison	59
		Elitis Energy Saving Calculator	61



**Handle images are for illustration purposes only, we reserve the right to change supplier.*



UK's Most Secure Windows & Doors

View our security comparison - page 60



Design Standards

For those seeking an additional layer of security, we offer the option to upgrade to the Secured by Design standard, a police initiative aimed at 'designing out crime' through rigorous testing of security features. This optional extra ensures that your windows not only provide a barrier against the elements but also act as a steadfast shield for your home's safety.



Works with Kubu

Our Smart windows, powered by Kubu, will alert you via your phone if your windows have been opened (and let you know) whether your windows and doors are secure or not. (See page 55)



KlawLoc

Advanced Locking system

Our windows are designed with your security in mind, incorporating advanced multi-point locking systems that include robust KlawLoc for enhanced protection. These locks are engineered to securely anchor the window to its frame, significantly reducing the risk of forced entry. Moreover, they are Kubu ready, ensuring an additional layer of security for your peace of mind. The KlawLoc is an upgrade option.



Long-life performance & quality assured

Exceptional air tightness and weatherproofing providing draught-free performance for longer. Fully accredited by the British Standards Institute (BSI) and approved by the Association of Chief Police Officers' Secured by Design initiative.



Laminated glass

The optional safety laminated glass remains intact due to the plastic layer that is baked between the two pieces of glass (meeting the Police Approved standard), is quieter (letting in less road noise), and features fade control (so your furniture will fade less in the sun).

**Handle images are for illustration purposes only, we reserve the right to change supplier.*

The logo features the number '10' in a large, white, sans-serif font. The word 'YEAR' is written in a smaller, white, sans-serif font inside the top curve of the '0'. Below the '10' is the word 'GUARANTEE' in a white, sans-serif font.

10
YEAR
GUARANTEE

Our guarantee for peace of mind

Our 10-year extensive product guarantee is designed to provide you with peace of mind when purchasing an Elitis product, covering you against product defects.

We are able to offer such a high level of guarantee as Elitis products are manufactured by us, an award-winning manufacturer. All products are bespoke and handcrafted in UK to the highest standards.

Our windows and doors are made in state-of-the-art modern factories so you can be sure of the quality of the workmanship and the product you choose for your home.



All installers of Elitis products are FENSA or CERTASS registered, this provides consumers in England and Wales, important cover when it comes to installation. It means that your windows are installed by a certified installer, that the work complies with building regulations, and importantly that you will have an insurance backed guarantee – which covers the installation of your new Elitis product.

By choosing an Elitis installer you will receive all the necessary paperwork to confirm the installation meets Building Regulation requirements. This paperwork is required to sell a property after windows, and some doors, have been replaced.



Elitis Sustainability

Made and recycled in the UK

The environment is important to us which is why we ensure our uPVC and aluminium products are designed to minimise waste and contain some recycled content where appropriate. 95% of our factory offcuts are recycled and we also recycle the windows and doors Elitis installers take out of homes when replacing with new ones.

uPVC remains a great durable, low maintenance and energy efficient option. Thanks to recent advances in recycling, uPVC products can be recycled numerous times, with the uPVC actually gaining strength when

recycled. However, virgin uPVC is used on external surfaces to ensure the perfect finish and no loss of colour stability. Aluminium is the most recycled material in the world and we have the very best recycling procedures in house to minimise any waste.

Buying Elitis windows and doors is good for your home, your pocket and the environment.





Re-useable and recyclable for hundreds of years

Research has shown that 95% of 'post-consumer' or end-of-life uPVC windows can be recycled. The official product life for a uPVC window or door is up to 35 years (BRE) and they can be recycled up to 10 times meaning 350 years of re-use with minimal impact on the environment.



Made and Recycled in UK

Environmentally responsible

At Elitis we are committed to sustainable developments in the uPVC industry. This is why we use waste windows frames, that would otherwise go into landfill and recycle the material to create brand new windows - windows made from windows, for closed-loop material sustainability.

Our windows represent a genuine sustainable option. Not only because they help reduce CO2 emissions, but also because uPVC is a fully recyclable material. Each year, tens of thousands of tonnes of uPVC are recycled, minimising impact on landfill waste sites.

Up to A+ Rated Windows – Lowering Bills

Fitting energy efficient rated windows minimises your heat loss to reduce carbon emissions and ensures money spent on heating your home isn't wasted. Multi-chambered uPVC frames and argon gas filled double glazed units deliver the best possible thermal efficiency. Our Elitis aluminium bi-fold doors have a U value of just 1.4W/m²k which meets the new Part L Building Regulations requirements for external doors.

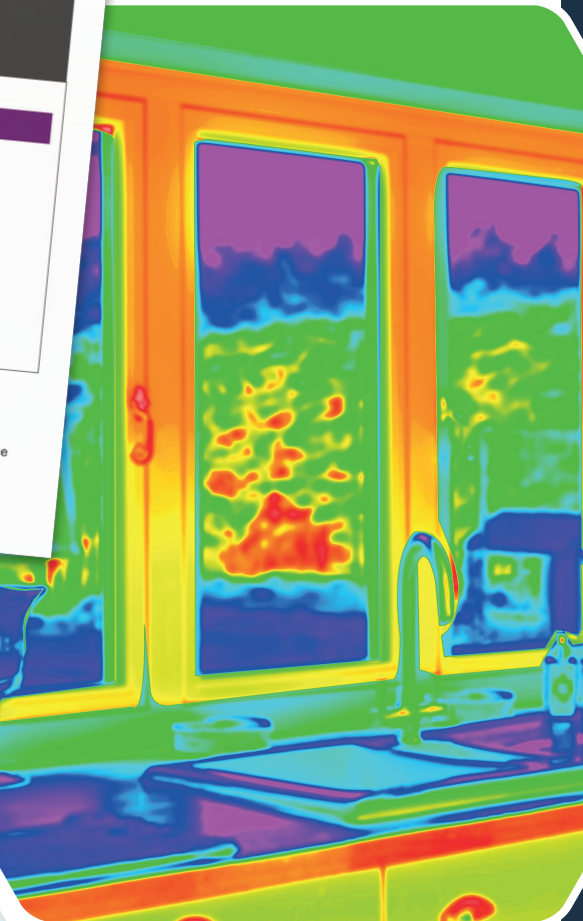

Low E Glass

Summer Keeps your home's interior cooler in warmer months

Winter Keeps your home's interior warmer in cooler months

Low E Coating on glass surfaces

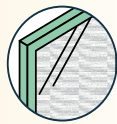

Most visible light passes through year round

Argon Gas Blend between panes

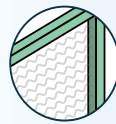

Most harmful UV rays are reflected outward year round

Most summer heat is reflected outside

In summer, most long wave solar heat energy is blocked

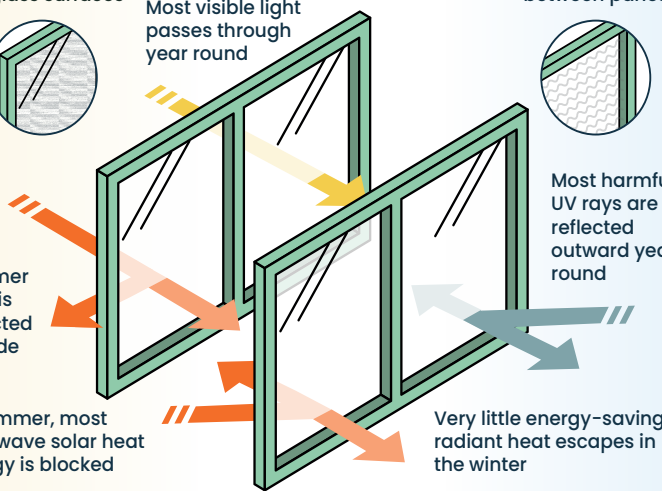

Lowers energy bills all year

0.9 U-value
W/(m²K)
Triple glazed

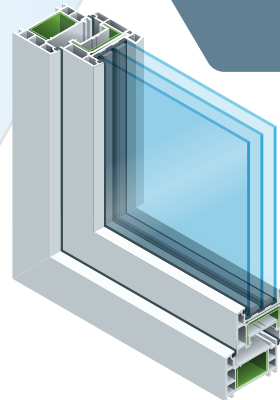

Experience unmatched energy savings with our windows, enhanced with a low-e coating and Argon fill. With u-Values as low as 0.9W/(m²K) in triple glazing, and an impressive A+ Window Energy Rating (WER), these windows not only offer superior thermal

performance but also contribute to lowering your energy bills. The low-e coating and Argon gas work together to minimise heat transfer, making your home more energy-efficient and comfortable.

Thermal Efficiency

Your uPVC window explained

THERMAL RATING

Compared with aluminium or wood, uPVC windows are low maintenance, have better insulation values and are able to reduce energy and heating costs.

WINDOWS MADE FROM WINDOWS

Up to 23% of our uPVC windows are made from recycled material. Brand new white pellets are formed from recycled content to create new pristine windows supporting the closed loop recycling system.

REDUCED HEAT LOSS

Warm edge spacers improve thermal efficiency at the glass's edge. 80% of a double glazed window's energy loss occurs here.

HIGH SPECIFICATION WEATHER SEALS

Our frames maintain their structural integrity over time as their unique construction actively absorbs noise pollution, significantly improving sound insulation. Impervious to rot, mould, mildew, UV radiation and ozone infiltration, ensuring durability and longevity for the lifespan of the window.

IMPROVED DRAINAGE PATH

Designed to allow water to run off the window into the frame and then drain out from the frame, reducing moisture in the home.

MULTI-CHAMBER OUTER FRAME

Our windows feature a multi-chamber outer frame design, meticulously crafted to enhance strength, thermal insulation and acoustic performance.

PREMIUM FINISH

Renowned for quality, the surface finish requires little or no maintenance ensuring a long-lasting pristine appearance.

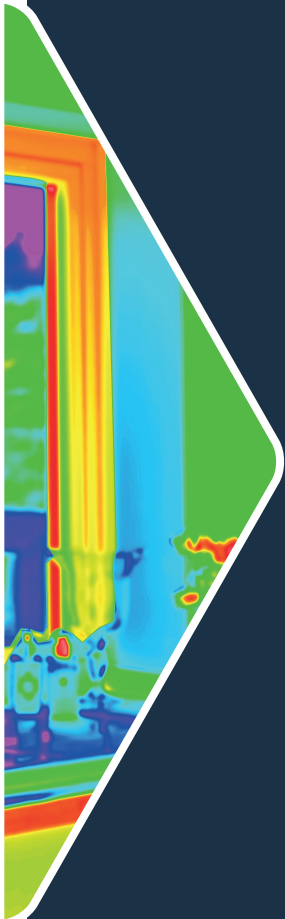



Potential Savings with New Energy Efficient Windows

Cost savings: £8,340

CO2 savings: 27,820kg

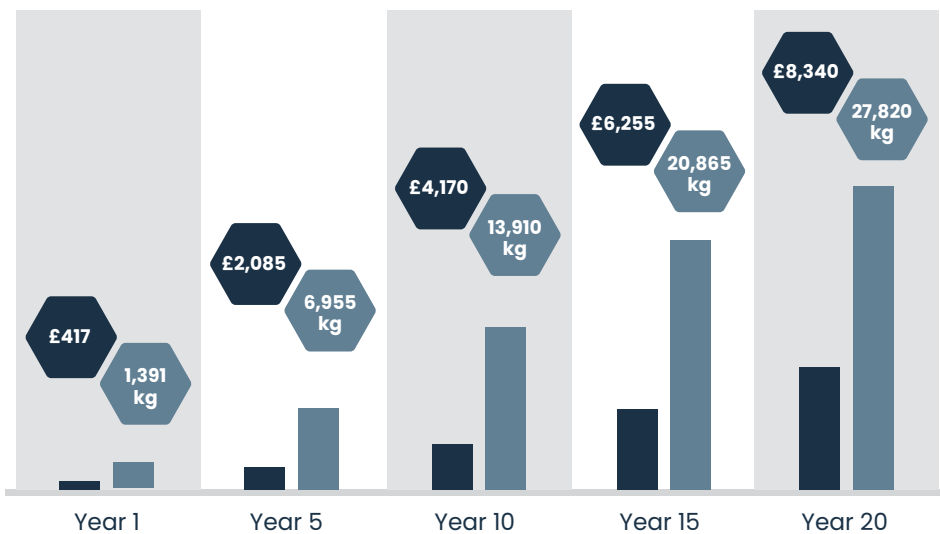

**Saving calculations based on detached house with mains gas and 24m² of window area. Upgrading from old uPVC double glazing to new triple glazing. (Correct as of April 2024) Calculations are estimates only and based on assumptions about the U Values of old windows being removed. Visit Elitis.co.uk for more details.*

Smart, Efficient, Secure

Elitis Windows



High security
window lock

Monkey Tail Handle

Flying Mullion



Our up to A+ rated uPVC double glazed windows, timber alternative windows and aluminium windows all come in a variety of stunning designs, deserving of any home.

Expertly designed and manufactured at our award-winning workshops in the UK, we deliver nothing less than the highest quality products, all backed up by our industry-leading 10-year guarantee. Keep your home

and family safe with our Kubu-ready, smart security. All our doors can be upgraded to Secured by Design standards – the official UK Police initiative.



View on elitis.co.uk

**Handle images are for illustration purposes only, we reserve the right to change supplier.*

Window Styles

Our Chamfered windows and doors combine the elegance and style of traditional timber with all the benefits of uPVC.

This range is ideal for those who wish to add or improve the period features of their homes. Its unique, unrivalled, aesthetic appeal makes this range the most attractive suite of windows and doors on the market today.

French Doors and Entrance Doors are available in the same colours to match your windows. Choose door frame profiles in the same style too for a seamless finish.



Chamfered

Our beautiful Sculptured Sash uPVC windows feature outward opening sashes, which stand proud of the face of the window frame and are the more typical style found in houses today.

This range is ideal for period properties and those who want to add character and enhance the appearance of their homes. The stunning and individual aesthetic of this range makes it a market leader.



Sculptured

Every home is unique and Elitis windows are designed and manufactured in the UK, offering you the widest choices and styles, all backed up by the longest guarantees in the industry.

Casement Windows

Our most popular range of uPVC windows. We offer unrivalled choice for different homes and style requirements.

Flush Sash Windows

Traditional looking window style with deceptively modern performance, flush sash windows are an excellent choice for heritage properties with a more traditional appearance.

10
YEAR
GUARANTEE



Equal Sightlines



Flush Sash



Tilt & Turn

Tilt and Turn Windows

Tilt and Turn Windows with a multi-point locking system and inward opening are the perfect choice for areas with adverse weather conditions, delivering effective performance without sacrificing on style.



*Handle images are for illustration purposes only, we reserve the right to change supplier.

Window Layouts

Whether you are looking to replicate the layout of your existing windows or want to change them to give your home a different look and feel then Elitis windows are

available in a wide range of layouts. Whatever layout of window you require we can manufacture it for you.

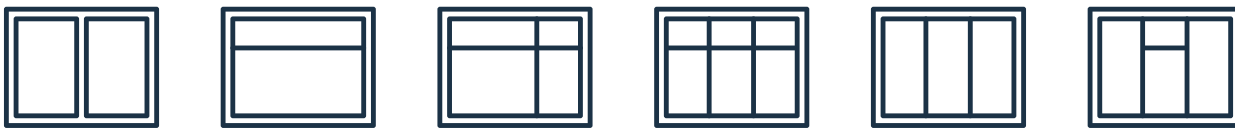

Leaded and Georgian

The design of your windows and doors have a big impact on the overall appearance of your home. Whatever the age of your property, the original windows and doors were designed to harmonise with it.

So it's important to consider what will look right for the building when you replace them. The right design and look can preserve or enhance the value of your home.

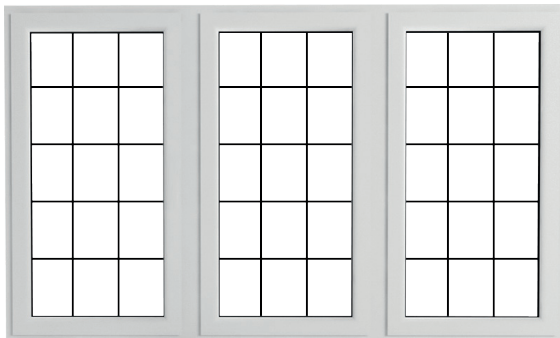

Square Leaded

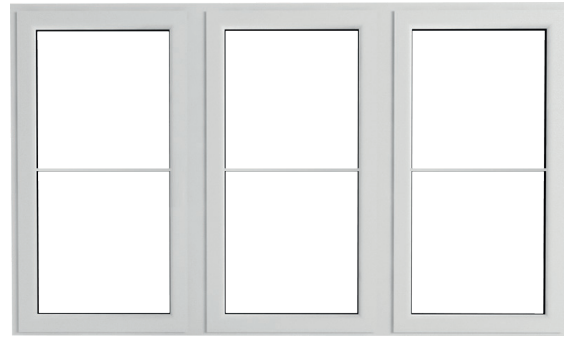

Single Georgian Bars



Georgian Bars in Fanlight



Authentic Georgian Bars

*This image is for illustration purposes only. For further details on Georgian or Astragal Bar options please ask your Installer.



Diamond Lead



Unequal Sightlines



Equal Sightlines

Sightlines

Good window design extends to the symmetry of window sightlines. Equal sightlines add balance and harmony - creating the perfect stylish finish.



Equal Sightlines

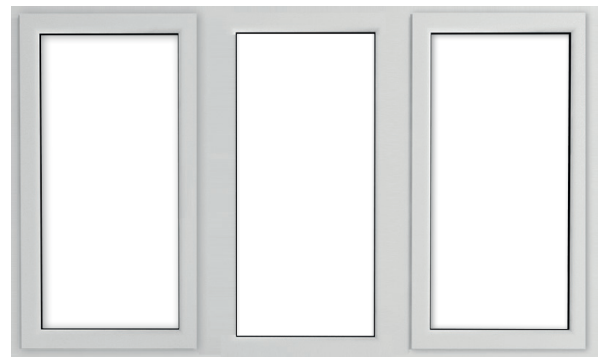

Unequal Sightlines





**Elitis
Window
Hardware**

Exclusive Elitis Scroll Handles

Standard uPVC window handles



WHITE BRONZE BLACK CHROME GOLD

Pear Drop Handles

(Optional upgrade)

Unique cranked design provides good clearance between the handle and the window.



SATIN CHROME POLISHED CHROME PEWTER PATINA BLACK ANTIQUE BRONZE

Monkey Tail Handles

(Optional upgrade)

Elegant design inspired by 19th century ironmongery.



SATIN CHROME POLISHED CHROME PEWTER PATINA BLACK ANTIQUE BRONZE

Peg Stays

Matching decorative peg stays are available with the Pear Drop and Monkey Tail handles.



SATIN CHROME POLISHED CHROME PEWTER PATINA MATT BLACK ANTIQUE BRONZE

Pear drop and Monkey Tail handles are available as an upgrade on uPVC windows



**Handle images are for illustration purposes only, we reserve the right to change supplier.*

Elitis uPVC Windows

10
YEAR
GUARANTEE



Energy Saving

Elitis uPVC double-glazed windows help keep your house warmer in winter and cooler in summer. These A Rated windows help save money on your heating bills by reducing heat loss through your windows. To ensure great performance, every window is made-to-measure to fit your home, with U-values as low as 0.8.

Reduce Noise Levels

Our uPVC double glazing helps reduce noise pollution from outside, providing great sound protection levels. If you live near a busy road ask your Elitis Installer about the glazing options available to further reduce noise pollution.



Long-life Performance & Quality Assured

Exceptional air tightness and weatherproofing for draught-free performance for longer. Fully accredited by the British Standards Institute (BSI) and upgradable to the Association of Chief Police Officers' Secured by Design initiative.

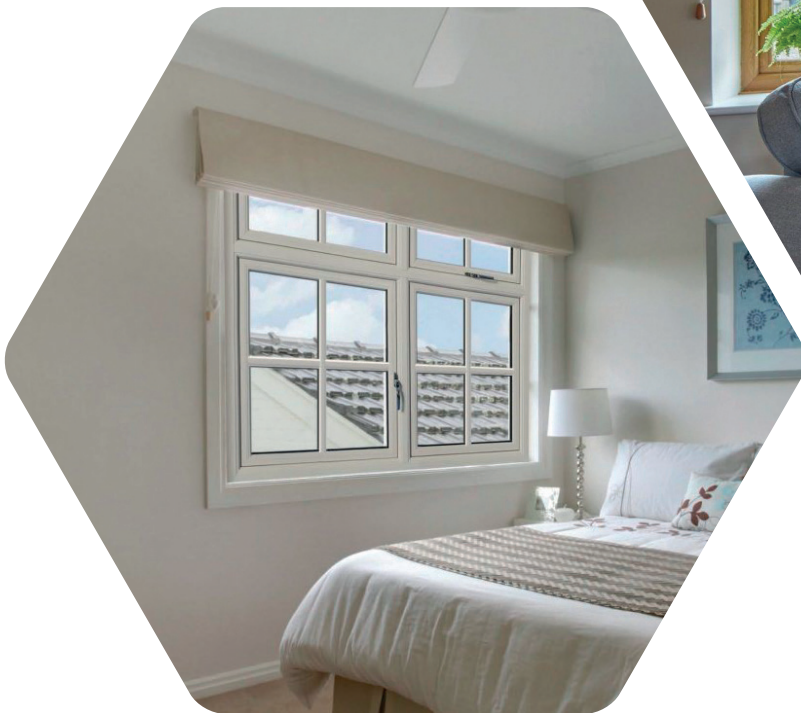

Locks

Our windows are fitted with KlawLoc multi-point locking as standard and can be upgraded to Secured by Design to keep you and your home safe.

Smart security

Our Smart windows work with Kubu Smart Security sensors to alert you via your phone of the security status of your windows.

Smart and Secure

Elitis uPVC windows can be upgraded to the official police security initiative, Secured By Design accreditation, which aims to enhance the security of buildings. Our windows undergo rigorous testing, all designed to protect against break-ins. These windows have been independently assessed, earning the British Standards Institute accreditations of BS6375 for weather performance and PAS24 for security. Elitis windows are equipped with key-locking security handles and come Kubu-ready as standard.



See page 55



View on [elitis.co.uk](https://www.elitis.co.uk)

**Handle images are for illustration purposes only, we reserve the right to change supplier.*

10
YEAR
GUARANTEE



Elitis Timber Alternative Windows

Whether you own a modern, period, conservation, listed or heritage home, Elitis Timber Alternative is a suite of distinctive and luxurious window systems to suit any property type.



Timber Style Mitre Joint



Timber Style Butt Joint



Flush Sash

The Elitis Timber Alternative window is designed and made in the UK. It was created with the enduring designs of British architecture in mind and has many bespoke options that can satisfy a range of homes, from the solid good looks of Georgian and Victorian properties right through to present-day modern homes.

The windows are a wonderful blend of traditional aesthetics and innovative design. Whatever period your property is, these timber alternative windows will look great as they mirror historical design and consider conservation guidelines, authentically replicating traditional timber sightlines.

Secured by Design



Police Preferred Specification



See page 55



View on [elitis.co.uk](https://www.elitis.co.uk)

A man with short brown hair, wearing a white t-shirt and dark overalls, is focused on his work in a timber mill. He is holding a long, light-colored piece of wood horizontally, with his hands positioned as if he is about to cut or inspect it. The background shows the industrial setting of a mill with various pieces of equipment and wood. A dark blue hexagonal graphic is overlaid on the bottom left of the image, containing the title text.

Elitis Timber Manufacturing Techniques

Modern technology traditional aesthetics

Elitis Timber Alternative windows use modern manufacturing methods while celebrating the techniques of traditional British craftsmanship. The joints are butted together to replicate timber, giving your windows and doors the authentic timber appearance.

The flush sash exterior is timeless and all the glass sightlines are perfectly equal, providing symmetry and style not available elsewhere. The internal shape and depth is authentic, giving an elegant and distinctively deep appearance.

Advanced technology with a traditional window appearance. Opt for the mechanically jointed flush sash window for a traditional look if you wish to avoid the diagonal weld.



Traditional Flush Sash



Timber Look Butt Joint

Elitis timber Alternative windows are fully welded, with the traditional 'butt joint' appearance that both homeowners and Conservation Officers are looking for – it is one of the ways that our windows have that authentic timber appearance but there is also the option of the mitre welded joint.

With Elitis Timber Alternative windows you have the look of a traditional window, but with all the benefits of modern technology delivering an energy efficient, virtually maintenance - free product.

A modern bedroom interior with a large window featuring three vertical panes. The window is set in a white frame and offers a view of lush green trees. Below the window is a bed with white pillows and a white duvet. To the left of the bed is a small round side table with a gold-colored lattice pattern, holding a vase of white roses. To the right of the bed is a tall floor lamp with a gold-colored base and a grey lampshade. The room has light grey walls and a wooden floor. A dark blue hexagonal graphic is overlaid on the bottom left of the image.

Elitis Aluminium Windows

Transform your home with our stylish aluminium windows

ELITIS[®]
ALUMINIUM



Secured by Design



Police Preferred Specification

Choosing the right aluminium windows for your home is an important decision. An investment that makes a real difference to how warm and secure you feel, as well as improving the look of your property. That is why we have carefully designed the Elitis Aluminium window and door system to combine stylish looks with the latest technical innovation. Building on years of experience, we've incorporated many unique features to create an incredibly thermally efficient, secure system, with unparalleled aesthetic appeal, that's available in a wide range of colours.

Designed for discerning homeowners that aren't willing to compromise, the Elitis Aluminium range is tailored for those who demand more for their homes.

Built around our innovative Thermlock[®] multi-chamber thermal break, we use a patented, strong and durable construction method, enabling us to hand tune each corner, ensuring every single window and door is finished to the highest standards.

Elitis Aluminium windows combine clean lines with exceptional thermal performance for up to an A+ Window Energy Rating.

Our innovative Thermlock® multi-chamber thermal design, hidden away inside each window and door, helps keep you and your property well insulated against the worst of the UK weather. This closed-cell, insulating chamber acts as a thermal break and works in conjunction with high performance glazing to create class leading thermal performance, far superior to traditional polyamide thermal breaks. Elitis Aluminium cills also feature this same technology coupled with innovative in-built weather sealing keeping draughts and rain safely outside.

Our versatile 72 - 80mm wide system is available in casement, French and fixed windows and has been designed to be sympathetic to the modern trend for light, airy interiors. Using slim sashes allows more light to flood into your home, helping create that important sense of space and tranquillity.

**ELITIS®
ALUMINIUM**

Each Elitis Aluminium installation is individually tailored to the exact requirements of your property. A range of different outer frame sizes accommodate different plaster lines and window reveals - ensuring a perfect, neat finish.

Aluminium Colour Collection

Traditional Colours



Contemporary Colours

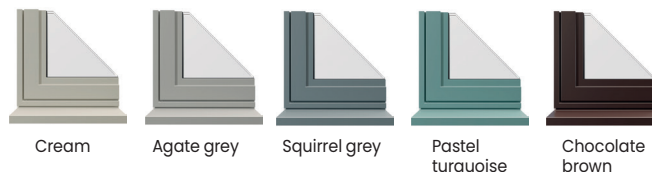

The Pargon Metallic Effect Range





**Exceptional
thermal
performance
combined with
refined looks**

10
YEAR
GUARANTEE



Elitis Doors

Designed and made-to-measure doors for your home. Whether you need a new front door, sliding or bi-fold doors in uPVC, timber alternative or aluminium we have the perfect option for you.

Secured by Design



Police Preferred Specification



Perfect mix of security and style



Composite Door



Bi-fold Door



Sliding Door



French Door

Expertly designed and manufactured at our award winning workshops in the UK. We deliver nothing less than the highest quality products all backed up by our industry leading 10 year guarantee. Keep your home and family safe with our Kubu ready, smart security. All our doors are tested to Secured by Design standards – the official UK Police initiative.

**Handle images are for illustration purposes only, we reserve the right to change supplier.*



View on elitis.co.uk



**Elitis
Composite &
Solid Core
Doors**

British designed and built

A quality front door creates a great first impression as you come home or when friends or family visit. Elitis uses the latest in composite door technology to achieve this. Our range of elegant, high-performing composite doors offers stunning visuals, while keeping your home protected and warm without requiring high levels of maintenance. Enjoy our 10-year guarantee that comes with purchasing an Elitis door.



High security standards

We take security seriously, offering industry-leading security features, including the optional Secured by Design accreditation.

Your Elitis door is manufactured to be compatible with Kubu Smart Security sensors, meaning they can be smart-activated with the Kubu Starter Kit. Your Elitis door comes with a 10-year mechanical warranty. For additional peace of mind, you'll receive a £2000 Ultion Guarantee with Kubu.

Made-to-measure

Elitis doors are made-to-measure for a perfect fit, which makes them more thermally efficient.



View on [elitis.co.uk](https://www.elitis.co.uk) 32



Features & Benefits



Traditional Doors

Our Traditional range is designed to replicate timber doors, with a realistic timber effect which requires almost no maintenance. A wide range of decorative glass options and obscured glass allow the homeowner to choose their preferred option.

Urban Doors (Smooth finish)

The Urban range boasts a unique, clean, authentic style that can be customised for any home, setting new standards in customisable, contemporary entrances. A 'smooth' door finish along with a choice of aluminium or colour-matched finishes.



Contemporary Doors (Woodgrain finish)

Grained contemporary doors are designed to replicate modern timber doors. Colour matching frame and a choice of decorative or obscure glass are available to complement these doors.

OTHER DOOR DESIGNS ARE AVAILABLE
Please ask your Elitis installer for more information.

Multi-point locking system & Multi layered core

Our multi-point lock range offers outstanding protection against attempted burglary with our doors having passed the rigorous PAS24 testing. The high quality lock consists of a series of hooks with a centre deadbolt lock. This impressive design will protect the your home against forced entry.

All locks featured on the composite doors are manufactured to exceptional quality standards and exceed current security regulations.



Elitis composite entrance doors feature a core that is protected from water damage by its high performance polymer skin. Along with stainless steel hinges and robust gaskets, your customers can enjoy a door with a perfect seal between the door and frame. With multiple seals, Elitis composite doors are excellent at keeping out draughts and will give homeowners a much warmer property, potentially resulting in lower energy bills.

74% of intruders go through the door

43% get through the door by forcing the lock

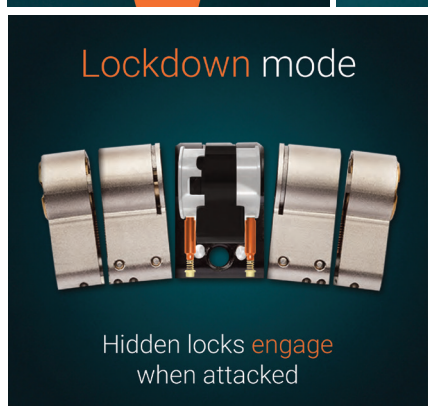

£5000
GUARANTEE

If an intruder snaps Ultion and breaks into your home we'll pay you £2000.

ULTION

Home Defence System

FITTED AS STANDARD
On Elitis doors*

Millions of doors in the UK can be opened quietly in under 10 seconds with normal tools. Even the most secure multi-point hook mechanisms are disabled when the cylinder lock is snapped. Securing your doors with Ultion defends your home from this and all other known attack methods.

*Fitted as standard on Composite and Sheerline Bi-fold, French and entrance doors. On uPVC French doors Ultion is an optional upgrade.



Door Accessories

Urn Knockers



WHITE



BLACK



GRAPHITE



CHROME



BRONZE



GOLD

Ponytail Knockers



GOLD



CHROME

Letterplates



ANTIQUE BLACK



GRAPHITE



CHROME

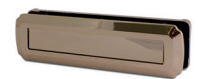

GOLD

Door furniture images are for illustration purposes only and door furniture may be subject to change.

Beautiful Finishes

To complement our doors, we offer a range of high quality door furniture and door hardware. All door accessories are covered by a four year surface finish guarantee.



Heritage Range

Balmoral Door Handles



WHITE



BLACK



ANTIQUE BLACK



GRAPHITE



CHROME



BRONZE



GOLD

Colours and styles may vary from those illustrated as we sometimes have to change suppliers for these products due to stock issues.

Ask your Installer for further details.

Exclusive Elitis Scroll Handles



WHITE



BLACK



SMOKY CHROME



CHROME



GOLD

Pad Door Handles



ANTIQUE BLACK



GRAPHITE



CHROME

Other colours available

Lever Pad Handle may not be suitable on all doors. Ask your installer for details.

Contemporary door furniture

The Pull Bar Handle is available in Brushed Satin only. Pull plates available in Chrome, Gold and Satin.



FINGER PULLS

PULL-BAR
Comes in 3 lengths

CENTRE PULL



FINGER PULL

Contemporary Pull Bar



Chrome Lever



Elitis French Doors

Why choose French Doors?

Elitis French doors let more light flood into your home and enable fantastic access directly into your garden. Choose between contemporary aluminium design, traditional timber alternative or low-maintenance uPVC.



10 YEAR
GUARANTEE



Perfect mix
of security
and style



Flush Sash



French Door – outside lights



Coloured Handles

French Door Handle

- ✓ Curved handle available in white, bronze, gold*, chrome*, black and satin silver.
- ✓ Straight Handle available in white, gold, chrome and black.
- ✓ PAS24 Compliant.
- ✓ Works with Kubu (See page 55 for more details).

* Gold and chrome curved handles are available as marine grade



View on [elitis.co.uk](https://www.elitis.co.uk)

uPVC French Doors

uPVC French doors create an elegant threshold between home and garden. Industry-leading weather seal and frame technology ensure unmatched energy efficiency. Outward opening French Doors can be combined with sidelights to flood your home with light.

One of the main benefits of uPVC French doors is how low maintenance they are. Made-to-measure, they will fit the aperture perfectly, providing an easy way to be cleaned. The sashes can open simultaneously, allowing for safer cleaning. uPVC is a low maintenance material that simply needs a wipe down to stay looking as good as the day they were installed. Your customers can feel confident that these Elitis supplied uPVC French doors won't rust, discolour or wear down over time.



Timber Alternative French Doors

Bring the outside in with our range of timber alternative French or single doors, adding character to your home all year round. We have a dedicated open-out flush door sash that suites with all the window systems, the perfect entrance to the garden or patio. Paired with our traditional butt hinges, you can recreate the period look of your property or create a new feature.



*Handle images are for illustration purposes only, we reserve the right to change supplier.



**Elitis
Patio Doors**

Patio Sliding Doors

Our Elitis patio sliding doors are available in up to 6 leaf options and combine safety and security with lifestyle choice and space. Each door comes with 6 point locking as standard.

Choice of styles

Elitis Patio doors have the option of a contemporary, straight-edged style, or the more sculptured traditional, decorative style.



Smooth Gliding



See page 55

Elitis patio sliding doors glide effortlessly on the rollers and are very easy to operate, handle and maintain, and due to the highly engineered and manufactured quality of our doors we can achieve much larger spans than many other systems allowing our clients to enjoy better sightlines with larger glazed areas.

Fully glazed or fitted with a mid-rail provides options to suit most design requirements.

uPVC Patio Doors

Fully glazed or fitted with a mid-rail provides options to suit most design requirements. All doors contain recycled uPVC which is better for the environment.



Our Sliding Door Specifications

- ✓ 6 point high security door lock with option to upgrade for the more security conscious
- ✓ 2 pre-compression rollers allowing door to seal prior to hooks engaging for smooth operation
- ✓ 1 centre latch for ease of day to day operation, incorporating dead-lock action when bolts and locks are engaged for added security.
- ✓ High performance co-extruded weather seals
- ✓ Galvanised steel reinforcement
- ✓ A variety of locking handle colours
- ✓ 28mm low-line glazing bead



ELITIS[®]
ALUMINIUM

Lift & Slide Patio Doors

Aluminium Colour Collection

Traditional Colours



Pure white



Hipca Gloss white



Anthracite grey



Jet black

Contemporary Colours



Cream



Agate grey



Squirrel grey



Pastel turquoise



Chocolate brown

The Pargon Metallic Effect Range



Silver



Bronze



Black

Key Features & Benefits

Maximised Views with Ultra Slim Frames

Featuring interlocks as slender as 52mm, our Lift & Slide Patio Doors are designed to offer unobstructed views, making your living space feel more expansive and connected to the outdoors.

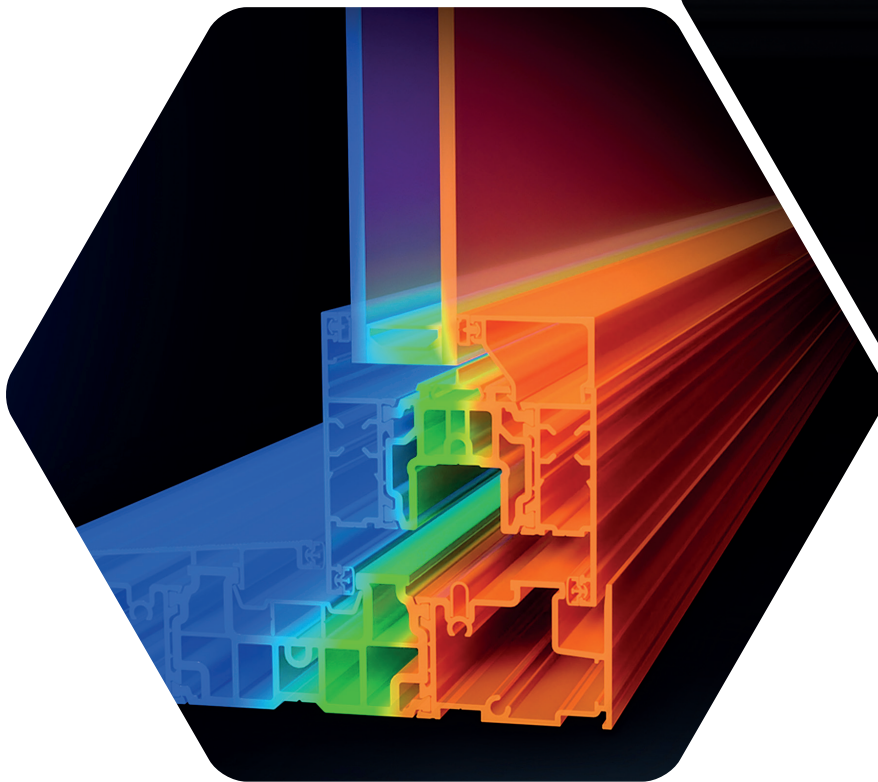

Exceptional Energy Saving Performance

Incorporating innovative Thermlock® technology, these doors provide industry-leading insulation. With a U-value of 1.4 for standard double glazing and an enhanced 1.0 w/m²K for triple glazing, our doors ensure your home stays warm in the winter and cool in the summer.

Combining high quality materials and top British craftsmanship, Elitis Aluminium Lift and Slide doors effortlessly combine state-of-the-art performance with outstanding aesthetics. Our industry-leading and technically advanced solutions are perfect for a room with a view. Virtually seamless moving from inside to outside with our zero threshold design, the perfect access without any obstructions. With slim sightlines and a stunning contemporary look and feel, the Elitis aluminium lift and slide patio doors maximise the light.

Over 450 different shades and finishes are available: metallic and matt colours, or even a special low maintenance and scratch resistant coatex finish. On top of that, your windows can even get a realistic wood structure.



View on [elitis.co.uk](https://www.elitis.co.uk)



ELITIS[®]
ALUMINIUM

**Classic
Heritage
Doors**

Aluminium Heritage Doors

Discover the elegance and functionality of the Elitis Classic Heritage Door, a proud member of our aluminium range.

Available in both single entrance and French door configurations, these doors blend traditional art deco style with modern features, offering a perfect solution for homes seeking the refined look of steel doors with the benefits of aluminium.

Elitis Aluminium Heritage Doors are designed to enhance the connection between your indoor and outdoor spaces. Slim sightlines and period-inspired designs allow for maximum natural light, creating an inviting atmosphere and a seamless transition to your garden or patio.

Every aspect of our Heritage Doors is engineered for perfection. From one-piece stainless steel tracks ensuring smooth operation to tri-material gaskets for reliable sealing, these doors are built to last.

Outstanding Security Features

Security features are built into every Elitis door, keeping you and your home safe. From bespoke Winkhaus Thunderbolt locks, to custom-designed VBH hardware, every element of the Elitis Aluminium Heritage Door has been designed to keep you and your home secure. All our lock options, including our high security Ultion lock upgrade – offer anti-snap, anti-bump and anti-pick protection while our patented† corner jointing method creates exceptionally strong frames, maximising the inherent strength of Elitis Aluminium's construction.

Incorporating high-security 3-star Ultion Cylinders and custom-designed hardware, our doors provide unrivalled security, keeping your home safe without compromising on style.



**Handles shown are an upgrade option.*

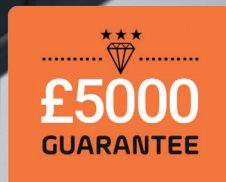

View on [elitis.co.uk](https://www.elitis.co.uk)



**Elitis
Aluminium
Bi-fold
Doors**

Elitis Aluminium Bi-folds

Elitis Aluminium bi-folds enable you to open up and transform your home. Providing that all important flexibility to enjoy your indoor and outdoor space as one.

ELITIS®
ALUMINIUM



Internal Locking



Open up your home and fill it with natural light

Combining the refined, architectural look of aluminium and the latest thermal and security technology, leaving you with beautifully balanced bi-folding doors. Bi-folding doors should maximise the light flooding into your home, and the enjoyment of your garden or patio. Bringing an improved sense of space and creating panoramic views that can transform interiors. They also need to offer reliable operation, while keeping heating bills low, and would-be intruders out. That is why we have designed our Elitis Aluminium bi-folds to offer you the perfect balance of refined looks, exceptional thermal performance and outstanding operation.

Bring the outside in

Elitis Aluminium bi-folds can help soften boundaries, creating an increased sense of space and a seamless transition between your garden and the inside of your home.

Slim, equal 138mm sash-to-sash sightlines ensure light bathes your interiors, even when your doors are closed. Giving you bright airy interiors no matter what style or configuration you choose.

Secured by Design



Police Preferred Specification

Quality components for flawless operation

Every element of the Elitis Aluminium bi-fold has been engineered to operate perfectly. One-piece stainless steel tracks in the head and threshold ensure smooth and reliable rolling of the sashes, while hinges rated to 120kg help keep every sash perfectly aligned during operation. No aspect of the door has been overlooked and we even use unique tri-material gaskets that feature a low-friction coating for smooth performance and reliable sealing.

Outstanding security features

Security features are built into every bi-fold, keeping you and your home safe. With a range of locks available from Ultion including the most durable 3-star, Police Preferred Specification lock. Few locks survive the test designed with the Master Locksmith Association and carried out by locksmiths but our locks are approved by locksmiths with the Sold Secure Diamond award.

All our lock options, including our high security Ultion lock upgrade – offer anti-snap, anti-bump and anti-pick protection while our patented† corner jointing method creates exceptionally strong frames, maximising the inherent strength of the aluminium construction.

Bi-fold benefits

- ✓ Super strong & secure
- ✓ Safe sliding roller mechanism
- ✓ Child safety system
- ✓ Available in 2 to 7 leaves

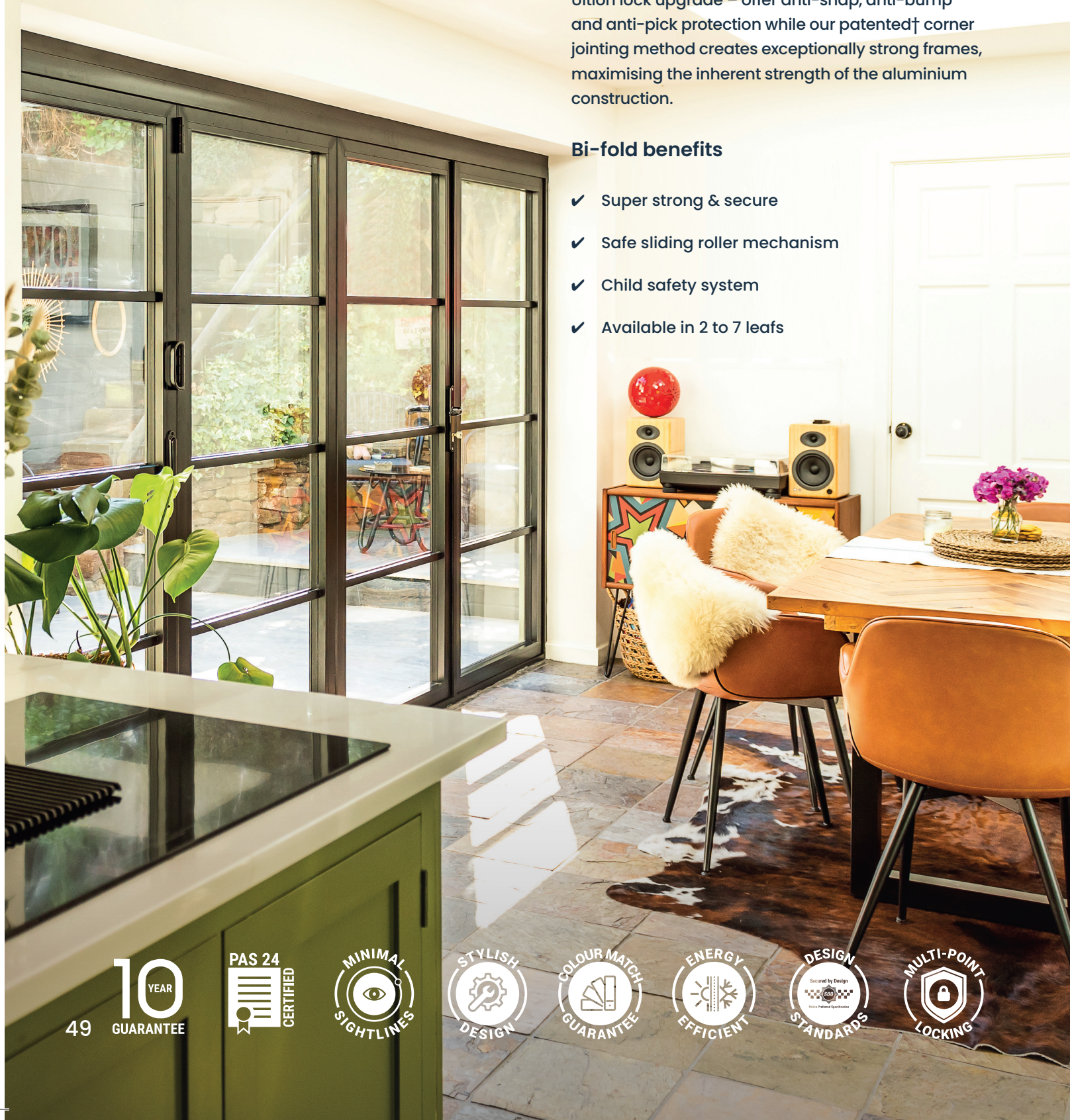

49 **10** YEAR GUARANTEE

PAS 24
CERTIFIED

MINIMAL
SIGHTLINES

STYLISH
DESIGN

COLOUR MATCH
GUARANTEE

ENERGY
EFFICIENT

DESIGN
STANDARDS

MULTI-POINT
LOCKING

Safe Bi-fold doors

The stainless steel wheels and tracks ensure a smooth opening to the outside, with a roller mechanism for a safer sliding operation. Elitis bi-fold doors are engineered using aluminium and can be configured to panel combinations of between two and seven.

These doors can cover entrance ways of up to 7 meters across. The entire system can be supplied to accommodate left, right and split openings. A traffic door option is also available, making it easier for you and your guests to come in and out without having to slide the door open in full.

ELITIS[®] ALUMINIUM



Single Roller



Secured by Design



Police Preferred Specification

Traditional Colours



Pure white

Hipca Gloss white

Anthracite grey

Jet black

Contemporary Colours



Cream

Agate grey

Squirrel grey

Pastel turquoise

Chocolate brown

The Pargon Metallic Effect Range



Silver

Bronze

Black



View on elitis.co.uk

Four threshold options – all fully weather sealed

Elitis Aluminium bi-folds come with four threshold options all featuring fully weather-sealed rebates that keep the worst of the British weather safely outside. These rebates also ensure doors aren't over-centred during operation, helping locks to engage correctly. Our doors also feature clever concealed drainage, eliminating the need for unsightly drainage cover caps.

We'll help you choose the right threshold for your installation so you get the most out of your new panoramic doors.



At a glance

- ✓ Up to 7 panes
Including 4/2/2 configurations
- ✓ Single and French door options
- ✓ Max 6.5 x 2.6m
- ✓ Max 1.2m sash width
- ✓ Max 120kg sashes
- ✓ 80mm deep outer frame
- ✓ 72mm deep sashes
- ✓ Slim 138mm sash to sash sightlines
standard across all styles
- ✓ Up to 44mm triple glazing
36mm on stepped sashes

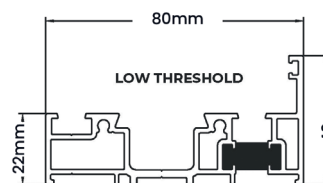
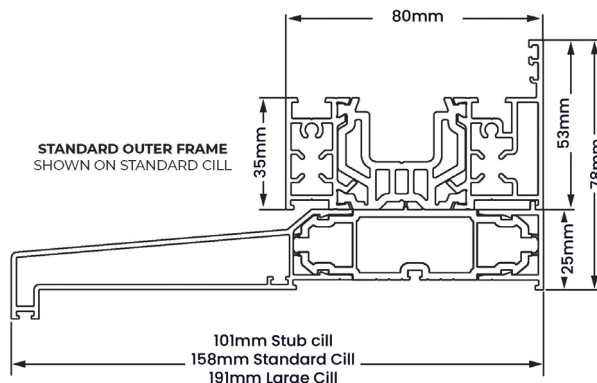
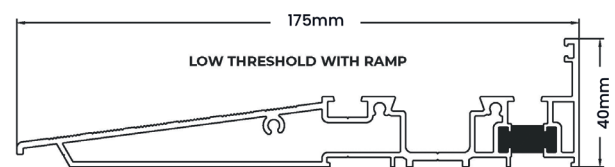
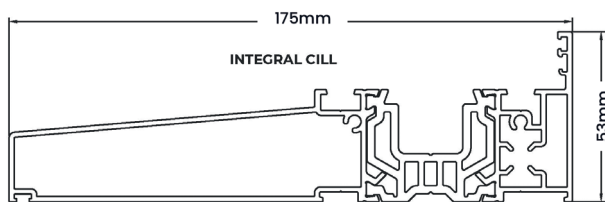

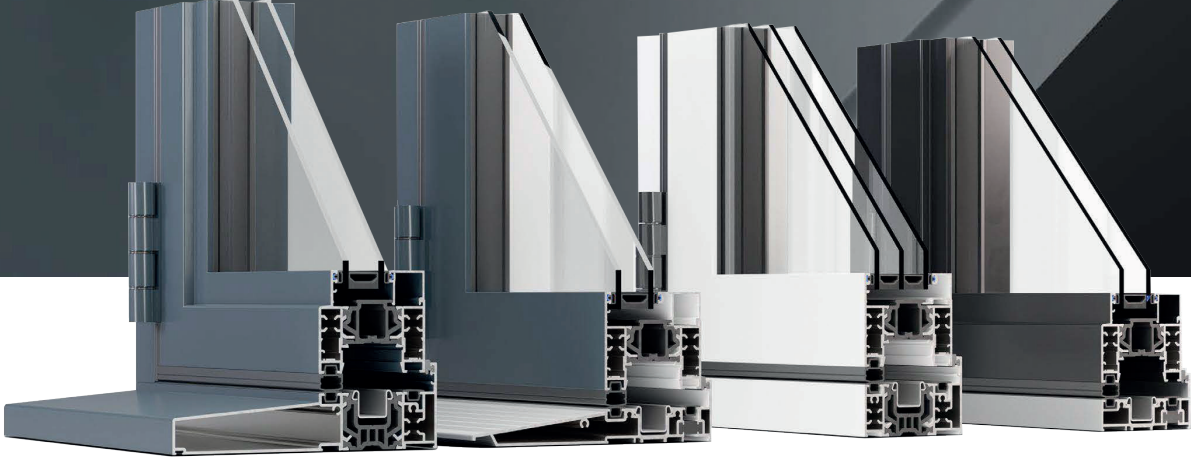

Integrated cill

Low threshold with ramp

Standard cill

Low threshold



ELITIS
ALUMINIUM

Elitis Roof Lanterns



View on [elitis.co.uk](https://www.elitis.co.uk)

Bespoke and purpose engineered aluminium thermally efficient lanterns.

Choosing the right roof lantern for your home is crucial. They should maximise light entry while retaining heat and deterring intruders. Enjoy more natural light and stunning nighttime views of the stars, enhancing your home's sense of space and tranquillity. Pairing the roof lantern with aluminium windows and doors creates a stunning, light-flooded area.



Secured by Design Upgrade Option

Our award-winning aluminium SI roof lantern, one of the UK's most secure, now offers a Secured by Design (SBD) upgrade. This security enhancement features additional clamping plates and stainless steel security screws, locking the laminated glass panels in place to deter opportunistic criminals* even if the rafter top caps are removed.

Colour options

Aluminium roof lanterns and windows are available in three standard powder coated colours, with the option of choosing a different colour for the interior to help you create the look that is perfect for your property. Bespoke colours can also be ordered to accent, or match your particular project requirements.

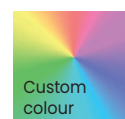
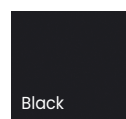
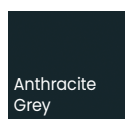

Aluminium Roof Lanterns

Constructed from robust aluminium, our modern roof lanterns with matching windows and doors require minimal maintenance. Consider the self-cleaning glass option for a virtually maintenance-free home extension that maximises light. This modern combination ensures your home stays warm and secure. The award-winning design offers spectacular views of the day and night sky, adding a sense of space and peace.

Optional Vent

The Elitis Lantern introduces a revolutionary, minimalist vent design that aligns perfectly with the lantern's rafters. Powered actuators allow for smart, automated control, eliminating the need for muntin bars and reducing leak risks. Fully thermally broken and utilising high-performance glazing, this vent feature further distinguishes the SI lantern.

The aluminium finish, both inside and out, is enhanced by durable powder coating for a stylish appearance. Every lantern is designed with security at its core, safeguarding your home. Experience our exceptional Thermlock technology for comfort and reduced heating bills, ensuring you and your home remain cosy. Advanced thermal technology protects against the UK's challenging weather.

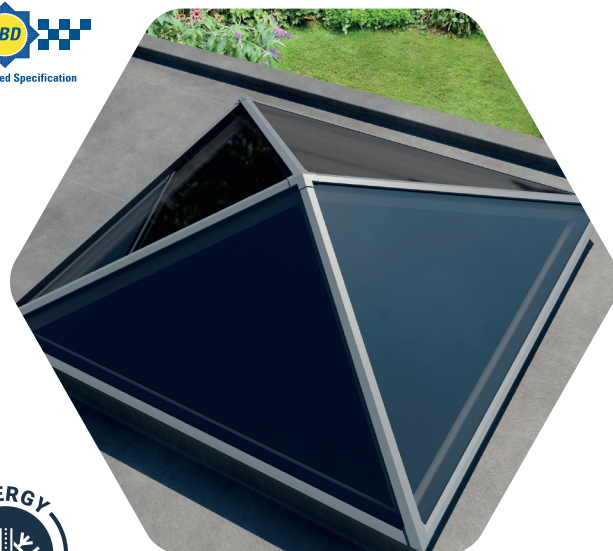



Be Sure it's Secure

All Elitis doors and windows work with Kubu as standard. Kubu Smart Security sensors monitor your locks in real-time, sending you an alert if your door or windows are locked or unlocked. Now you can check if your home is secure anytime, anywhere directly from your phone.

What does the Kubu App do?

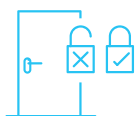

It lets you see the status of your door (locked/unlocked)



Get notifications with every turn of the key



From any place in the world



You can schedule notifications when you want



At anytime, day or night



It shows the history of your doors



On all the windows & doors in your home

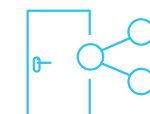

You can share your door with family and friends



On all the homes that you look after



Its perimeter feature stops you leaving your home unlocked

Did you lock your door?

We've all been there! With Kubu you'll never have to worry if your doors or windows are unlocked again. Kubu uses smart and simple technology to monitor your lock in real time. You'll be able to check the status of your Kubu integrated doors and window no matter where you are, at any time of the day, right from the your phone.

All our doors and windows work with Kubu, allowing you to add the smart sensors to them and keep your home more safe and secure. With our 15-year peace-of-mind guarantee, combined with Kubu Smart technology, your home is in safe hands with Elitis. With Kubu say goodbye to uncertainty and hello to complete peace-of-mind

Kubu starter pack



The Kubu starter pack is available for every Elitis door. The pack contains a Kubu Hub and one Door Sensor, allowing you to activate one lock.

Kubu £4000 Door Lock Guarantee

Your Kubu Door Lock automatically comes with a 10 year mechanical warranty. You'll also get £4000 Kubu Door Lock Security Guarantee as well.



uPVC Colours



View on elitis.co.uk

Woodgrain outside,
White Grain inside



OTHER INNER FRAME PROFILES AVAILABLE ON
SELECTED COLOURS

Timber Alternative Colours

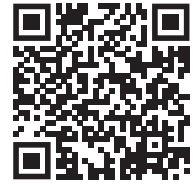

View on elitis.co.uk

Traditional Colour Collection
Woodgrain outside, White Grain inside



Contemporary Colours
Woodgrain outside, White Smooth inside



Composite Door Colours

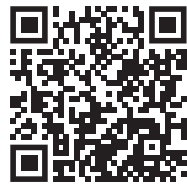

View on elitis.co.uk

Traditional Colours

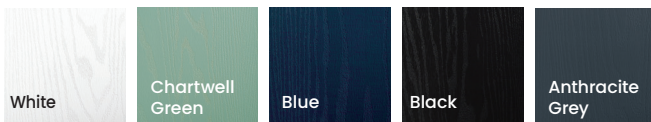

Contemporary Colours



FULL COLOR RANGE CAN BE VIEWED ON THE ELITIS WEBSITE.

OTHER COLOURS AVAILABLE ON REQUEST

Due to possible variations in the printing process,
please refer to physical colour swatches for an accurate
representation of the above colours.

Aluminium Colours



View on elitis.co.uk

Traditional Colours



Contemporary Colours



The Pargon Metallic Effect Range

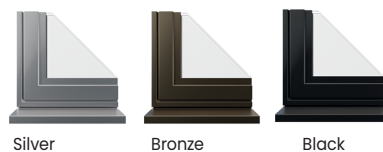



**Elitis Colour
Collection**



Security Comparison

High security
window lock



uPVC
Page 20



Timber Effect
Page 26



Aluminium
Page 32

£5,000 Ultion Guarantee	Y	Y	Y
Secured by Design	Optional	Optional	Optional
BSI 14001 certificated	Y	Y	Y
Advanced Locking system (Multipoint locking)	Y	Y	Y
Forced entry tested	Y	Y	Y
Hinge protectors for added security	Y	Y	Y
Multi-point Locking	Y	Y	Y
Safety Laminated Glass*	Optional	Optional	Optional
Works with Kubu	Y	Y	Y
Fire Escape Hinges	Y	Y	Y
3 star cylinder as standard	Y	Y	Y
PAS24:2016	Y	Y	Y

*where required by SBD. Speak to your installer and check order paperwork for glass specification.

*Handle images are for illustration purposes only, we reserve the right to change supplier.

Energy Saving Calculator

Discover how much replacing your old windows with energy saving Elitis windows could save you.

3 Simple Steps

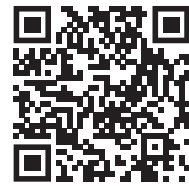

View on elitis.co.uk

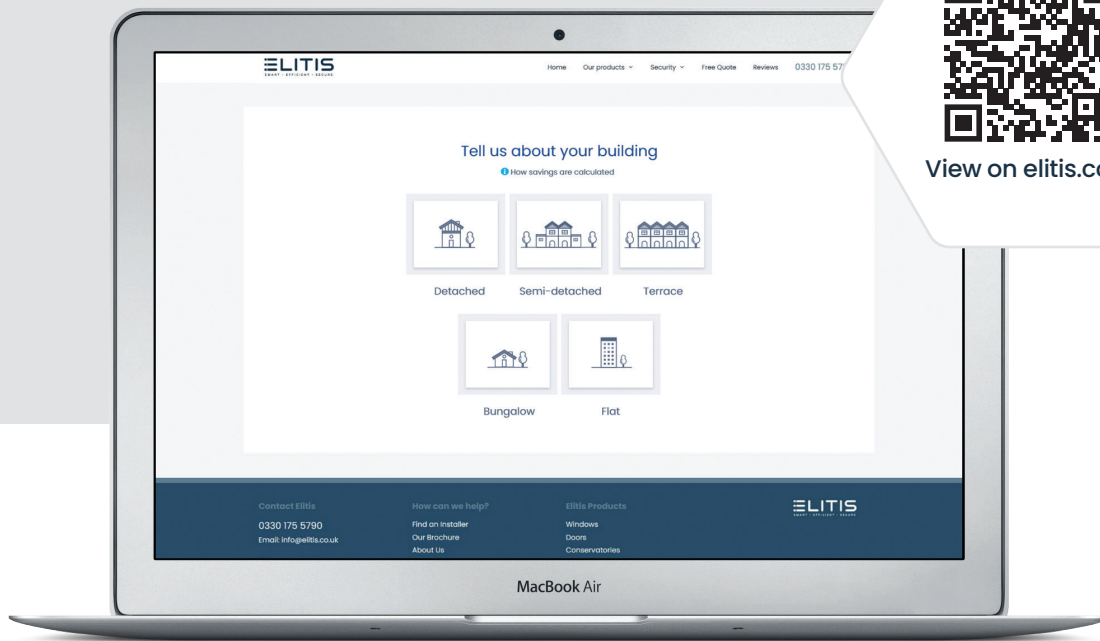

1

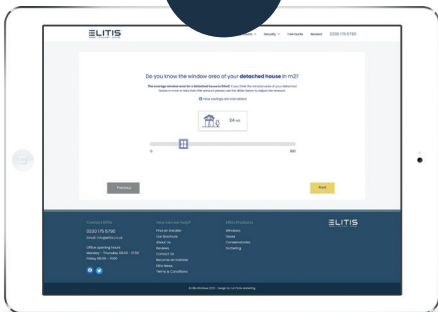

Enter your property details, including current window type

2

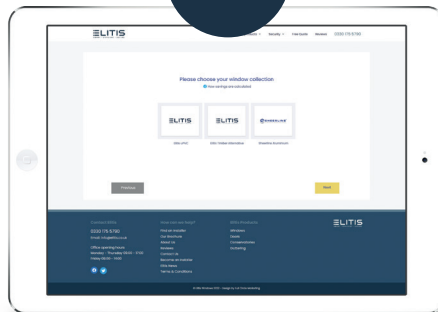

Select the new Elitis Windows you'd like

3



See how much you can save!



Colours shown in this brochure are for illustrative purposes only. Exact colours may differ due to the printing and manufacturing processes used. The images, drawings and data shown in this brochure are for illustrative purposes only and are not binding in detail, colour or specification. We reserve the right to make changes to the product specification as technical developments dictate and without prior notice. Please check your order confirmation for final product details.



Tel: 0330 175 5790

Email: info@elitis.co.uk

Web: www.elitis.co.uk

v7/03/2024