

 DESIGNED
& PRODUCED
IN THE UK.

#CraftYourDoor



CRAFTSMAN

STYLISH.
DISTINGUISHED.
HANDMADE.

solarcalibrenorvik.com



**SOLAR
CALIBRE DOORS**

A part of the **Solar Group.**

CONTENTS

INTRODUCTION

Solar Calibre Craftsman.....	pg 3
Simply a better class of door.....	pg 4-5
A door engineered to perform.....	pg 6
Dressed to impress.....	pg 7
Let the daylight flood in.....	pg 8-9
A colourful array of choice for your home.....	pg 10-11

OUR CONTEMPORARY DOORS

Contemporary styles.....	pg 15
The Foxley (MFF5).....	pg 16
The Albury (MFJ3).....	pg 18
The Whittingham (MF37).....	pg 20
The Glengarry (MFF6).....	pg 21
The Rufford (MF36).....	pg 22
The Mercia (MFC3).....	pg 24
The Rockingham (MFH9).....	pg 26
The Hampton (MF47).....	pg 27
The Dalby (MFH6).....	pg 28
The Wentwood (MFF11).....	pg 30
The Portland (MF60).....	pg 31
The Charlcote (MF61).....	pg 32
The Heartwood (MFM7).....	pg 33
The Whinfell (MF6F).....	pg 34
The Winterfold (MF6G).....	pg 35

OUR TRADITIONAL DOORS

Traditional styles.....	pg 39
The Sherwood (MFD5).....	pg 42
The Parkhurst (MF23).....	pg 43
The Arden (MF11).....	pg 44
The Marston (MF03).....	pg 46
The Shackleford (MF85).....	pg 48
The Highgate (MFM2).....	pg 49
The Ashdown (MF15).....	pg 50
The Charnwood (MFA3).....	pg 52
The Newstead (MF04).....	pg 54
The Epping (MF14).....	pg 56
The Dean (MF07).....	pg 58
The Galloway (MF08).....	pg 59
The Hatfield (MFM3).....	pg 60
The Silverhill (MFM5).....	pg 61
The Kensington (MFM5)(K).....	pg 62

CRAFT YOUR PERFECT DOOR

Colour.....	pg 66
Decorative panel & glazing.....	pg 67-72
Hardware.....	pg 73-83
Frame, sill & threshold.....	pg 84-85
Craftsman Guarantee.....	pg 86-87
Thermal and solid core.....	pg 88
Accreditations.....	pg 89
Customer support.....	pg 90
More from Solar Calibre Doors.....	pg 91



SOLAR CALIBRE CRAFTSMAN

THE PRECISION ENGINEERED TIMBER DOOR – A TRUE INNOVATION FOR YOUR HOME

The Solar Calibre Craftsman door is a door that speaks of precision engineering, quality construction and stunning good looks. With 30 door styles to choose from and with 24 beautiful lifestyle colours available, Solar Calibre Craftsman is a truly outstanding door.

Your home deserves the very best and Solar Calibre can provide that very thing. From our state-of-the-art premises in Huthwaite, Nottinghamshire, Solar Calibre have been building beautiful door sets since the 1990's. Named after the beautiful woodlands of Britain, the Craftsman is our premium timber door and is exceptional in every way.





SIMPLY A BETTER CLASS OF DOOR

A CLASS LEADER IN STRENGTH, SECURITY AND AUTHENTIC CRAFTSMANSHIP

We are proud to state that the Solar Calibre Craftsman door is second to none and the care and skill put into our doors shines through whilst the innovation and

engineering will bear out over its lifetime. Named after the beautiful woodlands of Britain, the Craftsman door is a tangible investment in your home.

- **Precision engineered to last**
A combination of a Kerto Q core, Sapele mahogany lipping and Tricoya facings provide a stable, hard-wearing, water resistant door
- **Two door slab choices - 44mm and 54mm**
Whatever your requirement or application, we offer both 44mm and 54mm door thicknesses with double rebated doors with triple weather seals
- **Thermal core option**
For the best in energy efficiency opt for a thermal door with a Polyurethane insulating foam core
- **A complete hardware choice**
Four individual ranges to choose from that include: handles, knockers, letterboxes and centre door pulls
- **Beautiful glazing options**
Over 30 elegant glazing styles are available for many of the Craftsman door styles
- **Low-E glass panels**
Wherever possible we supply an energy efficient glass specification as standard - see page 68-70
- **Safe and secure**
The unique construction of a Craftsman door provides an incredibly strong defence for your home
- **24 stunning colours**
From fiery reds to cool blues and all the shades in between, our colour range is first class
- **Frame, sill and threshold options**
A wide range of options to complete your door specification including Part M low threshold
- **Document L Compliance**
Meets UK Building Regulations for replacement door applications

WHY AN ENGINEERED TIMBER DOOR AND NOT A STANDARD TIMBER DOOR?



As beautiful as a traditional timber door can be, wood in its purest form is not the best material for this application. We have “designed out” all of the inherent problems usually experienced, and the Craftsman is an all round better, more reliable door for your home.

- No yearly maintenance
- No warping and twisting
- No draughts caused by shrinkage
- No rotting and deterioration
- No weather penetration
- No unstable timbers
- No flaking and crazing of paint finish
- No sticking and catching

A DOOR ENGINEERED TO PERFORM

THE MOST INNOVATIVE, HIGHLY ENGINEERED DOOR,
DIRECT FROM SOLAR CALIBRE

It has taken more than two decades of research and development for the Craftsman door to evolve into the innovative, structurally sound product that we know today. Using years of experience in joinery and traditional craftsmanship, whilst harnessing the latest in innovative technologies and materials, the Craftsman door has ascended as the industry leader.

Our development team and workforce strive to produce the very best doorsets in the market place. Their craftsmanship and attention to detail are obvious in the complex construction and advanced materials used in each and every Craftsman door, guaranteeing a sound door for many years to come.

Strong and Secure: The sturdy door blade with solid core and timber/aluminium capped frame is an ideal choice for quality, strength and the best in innovative engineering.

Craftsman doors are available as 44mm blade (solid or thermal) and 54mm blade (solid or thermal)

SOLAR CALIBRE ARE PROUD
TO MANUFACTURE WITH...



DRESSED TO IMPRESS

THE PERFECT DOOR FURNITURE TO DRESS YOUR SOLAR CALIBRE CRAFTSMAN DOOR.

We've selected beautiful door hardware that complements the Craftsman door range perfectly. Whether your chosen style is a classic panelled door or a more contemporary door with a grooved design, we have the ideal hardware in range.

All Solar Calibre Craftsman doors come with a standard handle, letterbox and knocker in a choice of four colours, four sturdy stainless steel or brass hinges and a secure multi-point lock as standard. See page 72-79 for details.



STANDARD SUITED HARDWARE

Handle (lever and pad), letterboxes, knocker and spy hole available in four finishes: Polished Gold, Chrome, Satin and Black

CONTEMPORARY HARDWARE

Sleek, elegant furniture suitable for our contemporary door designs in brushed stainless steel. Choice of three handle styles, a pull and two knockers.

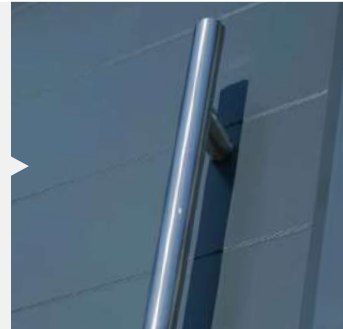

PREMIUM HERITAGE HARDWARE

Beautifully hand forged in either a Black, Pewter, Brass or Chrome finish. Choose from three handle designs, a pull, three knockers and a letterbox.

SWEET HARDWARE

"Edgeless" hardware that looks modern and stylish. Handle, letterbox, knocker and escutcheon available in Gold, Rose Gold, Chrome and Black finishes.



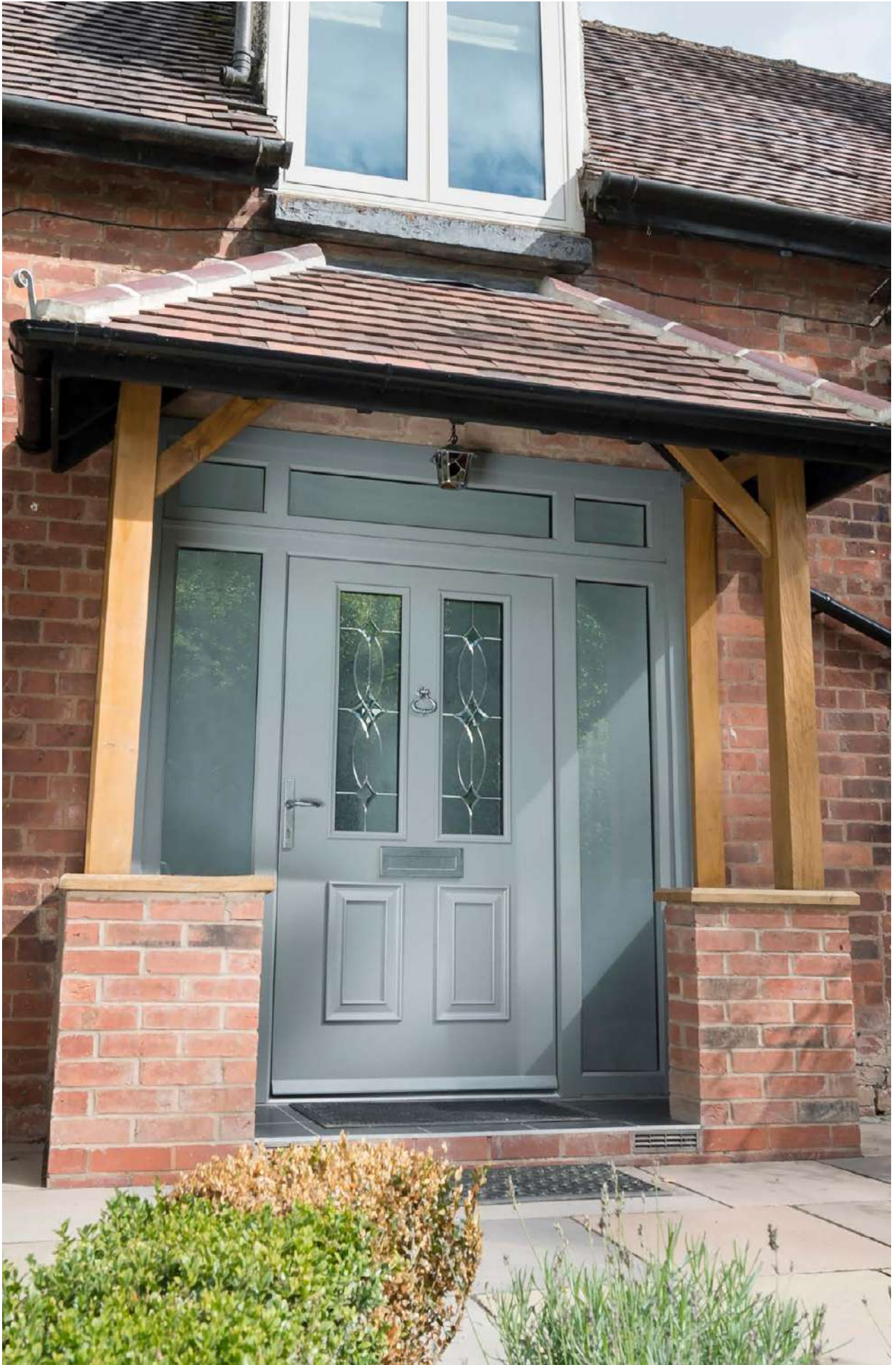

CRAFTSMAN PRODUCT RANGE

LET THE DAYLIGHT FLOOD IN

UP TO 30 GLASS DESIGNS TO PERSONALISE YOUR HOME WITH STYLE.

A glazed panel in your Solar Calibre Craftsman door not only has the practical benefits of allowing light in, it also lets you reflect your own personal taste, style and creativity, effortlessly. Choose from up to 30 amazing glass designs to create that perfect first impression.

We have selected the most elegant and attractive designs which complement our stunning range of door styles. Whether you have chosen a traditional or contemporary style, we have the ideal glazing choices

to bring your door to life. Looking for something quirky? Choose a contemporary design for a traditional door or vice versa.

All our glazing products are manufactured to conform to the same exacting high standards as your Solar Calibre Craftsman door, guaranteeing you peace of mind for years to come. Please note that wherever possible we supply energy efficient glass units as standard - see page 68.



ELEGANT GLAZING: FINESSE IS JUST ONE OF UP TO 30 DIFFERENT DECORATIVE GLASS DESIGNS AVAILABLE WITH YOUR CRAFTSMAN DOOR. WITH ITS LINEAR MOTIFS, ORGANIC BACKING GLASS AND CRYSTAL STYLE CENTRE, IT IS LITTLE WONDER THAT IT IS ONE OF OUR MOST POPULAR DESIGNS.

A COLOURFUL ARRAY OF CHOICE FOR YOUR HOME

WITH PRIMER, BASECOAT AND TOPCOATS –
THAT'S EQUIVALENT TO 10 COATS OF PAINT

Bring your door to life with one of Solar Calibre's lifestyle colours. Inspired by nature and our rich heritage, each shade delivers a unique character to your home. Be inspired by our latest colour palette and let your creativity run free.

Our paint, however is not just all about looks. Every door leaves our workshop with two water based layers of colour, two of undercoat and a primer, each applied using the latest spray technology. All four layers add up to the equivalent of an impressive 10 coats of paint. With such a hard-wearing finish, you will be enjoying it for many years to come.

10

WAX SEAL Page 49	SUMMER CORAL* Page 50	LEMON CURD* Page 62
PITTED OLIVE Page 24	BOTTLE Page 61	CHARTWELL Page 27
PEACOCK Page 46	CAMBRIDGE BLUE* Page 30	DEVONSHIRE* Page 34

<p>SAVILE ROW Page 52</p>	<p>MULBERRY Page 60</p>	<p>MERLOT* Page 48</p>
<p>BOURNVILLE Page 42</p>	<p>MANNEQUIN* Page 28</p>	<p>POTTER'S WHEEL* Page 18</p>
<p>FRENCH SAGE Page 26</p>	<p>VELLUM Page 32</p>	<p>CHALK CLIFF Page 33</p>
<p>DOVE Page 21</p>	<p>PEBBLE GREY Page 22</p>	<p>AGATE GREY Page 35</p>
<p>SMOKESTACK Page 20</p>	<p>ANTHRACITE Page 16</p>	<p>WHITBY JET Page 58</p>



Colours are representative only.
* Paint mixed in-house.



OUR
CONTEMPORARY
DOORS

CREATE YOUR OWN LOOK WITH OUR VERSATILE RANGE OF MODERN DESIGNS. OUR RANGE OFFERS EVERYTHING FROM COSY, COUNTRY CHARM TO STYLISH CITY CENTRE LIVING AND HAVE BEEN DESIGNED TO PERFECTLY COMPLEMENT YOUR HOME.

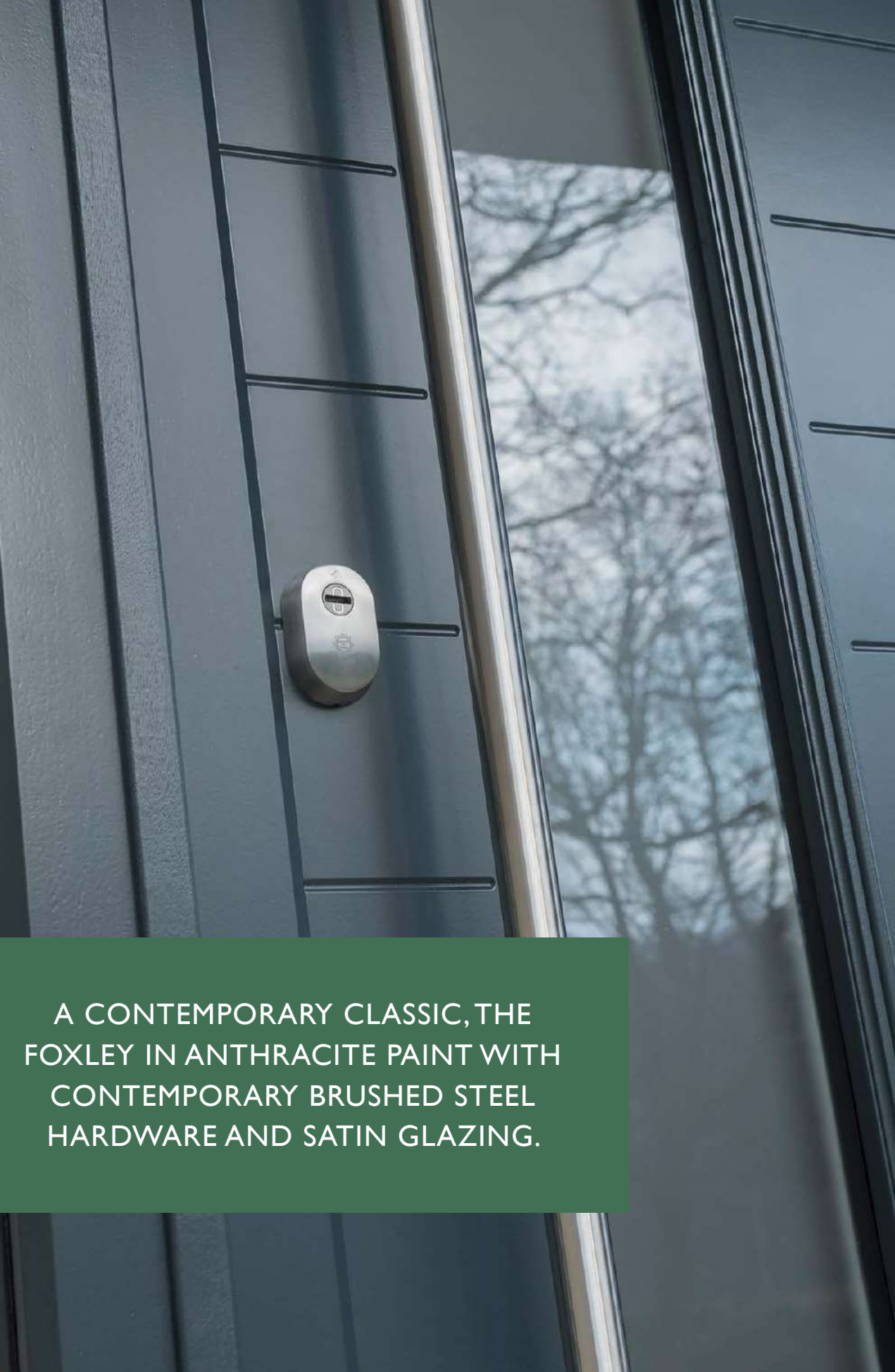

A CONTEMPORARY CLASSIC, THE
FOXLEY IN ANTHRACITE PAINT WITH
CONTEMPORARY BRUSHED STEEL
HARDWARE AND SATIN GLAZING.

CONTEMPORARY STYLES

THE MODERN CLEAN LOOK OF THE SOLAR CALIBRE CRAFTSMAN GROOVED DESIGNS IS KEY TO THE CONTEMPORARY RANGE.

Using routed grooves to give the impression of tongue and groove boards, gives a designer look without any of the known downsides. There are no issues with twisting planks due to extremes of weather or moisture and no peeling or crazing of paint when boards swell or contract.

Our growing selection of modern designs have become very popular in recent years. The Foxley, for example, with its characteristic long narrow glazed panel is the

epitome of modernity when teamed with our stylish brushed stainless steel hardware suite.

The versatile looks of The Rufford, The Albury and The Whittingham when dressed in Black Premium Heritage Hardware, afford a cosy, country charm or alternatively with Polished Chrome hardware look perfectly at home in the city.

1. The Foxley p16
2. The Albury p18
3. The Whittingham p20
4. The Glengarry p21
5. The Rufford p22
6. The Mercia p24
7. The Rockingham p26
8. The Hampton p27
9. The Dalby p28
10. The Wentwood p30
11. The Portland p31
12. The Charlcote p32
13. The Heartwood p33
14. The Whinfell p34
15. The Winterfold p35



THE FOXLEY

MFF5

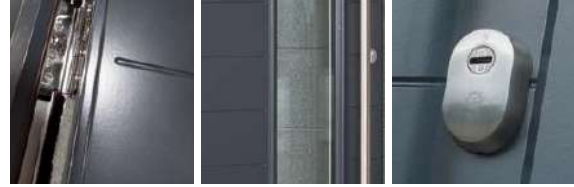

The Foxley is a popular addition to the contemporary range of Craftsman doors. With its long single panel, The Foxley is as elegant as it is practical. Teamed with Brushed Stainless Steel hardware, this door is a modern classic.

The long narrow glazing aperture of the Foxley may be positioned on the left, the right or can be centred.



PVC-U Frame:

Min width : 854mm

Max width : 1202mm

Min height : 2051mm

Max height : 2195mm

Timber Clad Aluminium Frame:

Min width : 842mm

Max width : 1190mm

Min height : 2045mm

Max height : 2189mm

All sizes exclude Timber or PVC-U sills and extensions.

If a low threshold is required please deduct 7mm from height.

Photo: The Foxley in Anthracite with Satin glazing and Contemporary Brushed Stainless Steel hardware (in-line bar handle) with a timber capped aluminium frame

DECORATIVE OPTIONS



1



2



3



4

- 1. Diamond Bevel*
- 2. Diamond Red*¹
- 3. Elegance
- 4. Murano Black*



5



6

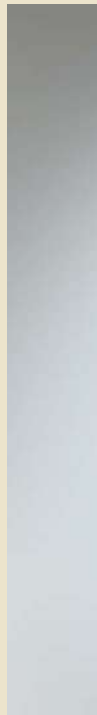

7



8

- 5. Prairie *
- 6. Reflections
- 7. Satin *
- 8. Obscure*²

*Also available in Diamond Blue, Grey or Green

¹Also available in Murano Blue, Red, Green or Purple

² See page 68 for all choices

THE ALBURY

MFJ3

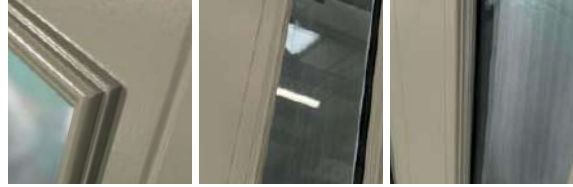

A simple yet assured design, the Albury combines integrity of design with a look that complements any home and is also suitable for a back door application.

18

PVC-U Frame:

Min width : 724mm	Max width : 1202mm
Min height : 1865mm	Max height : 2195mm

Timber Clad Aluminium Frame:

Min width : 712mm	Max width : 1190mm
Min height : 1859mm	Max height : 2189mm

*All sizes exclude Timber or PVC-U sills and extensions.
If a low threshold is required please deduct 7mm from height.*

Photo: The Albury in Potter's Wheel with Murano Blue glazing and Black ProLinea hardware with a timber capped aluminium frame

DECORATIVE OPTIONS



1



2



3



4



5



6



7



8



9



10

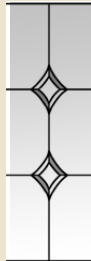

11



12



13



14



15

- 1. Diamond Bevel*
- 2. Diamond Red*¹
- 3. Fleur*
- 4. Murano Red*²
- 5. Dorchester Blue³
- 6. Flair
- 7. Finesse
- 8. Prairie
- 9. Simplicity³
- 10. Elegance
- 11. Crystal Diamond *
- 12. Diamond Cut
- 13. Reflections
- 14. Satin*
- 15. Obscure*⁴

*Laminate glass option available

¹Also available in Diamond Blue, Grey or Green

² Also available in Murano Blue, Black, Green or Purple

³ Also available in Dorchester Amber or Green

³ See page 68 for all choices

Our decorative glazing designs are supplied with a choice of backing glass see page 69

THE WHITTINGHAM

MF37

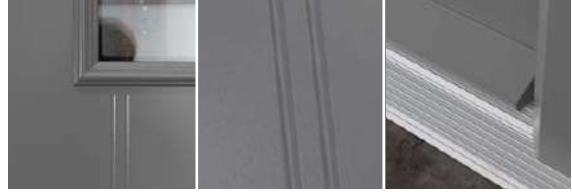

The feature double groove design of the Whittingham is unique in the Craftsman range and gives this door a sharp twist. Add your choice of glazing to complete the desired look.

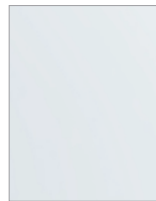

Satin *



Obscure *
See page 68
for all choices

PVC-U Frame:

Min width : 724mm

Min height : 1865mm

Max width : 1202mm

Max height : 2195mm

Timber Clad Aluminium Frame:

Min width : 712mm

Min height : 1859mm

Max width : 1190mm

Max height : 2189mm

All sizes exclude Timber or PVC-U sills and extensions

If a low threshold is required please deduct 7mm from height

Photo: The Whittingham in Smokestack with Obscure glazing and Polished Chrome ProLinea hardware with a timber capped aluminium frame

THE GLENGARRY

MFF6



The Glengarry has a bold and uncompromising design with its horizontal lines and trio of small windows. Its unapologetic modern appearance is a beautiful statement for any home. The three glazing apertures of the Glengarry may be positioned on the left, the right or centred.



PVC-U Frame:

Min width : 724mm

Max width : 1202mm

Min height : 1865mm

Max height : 2195mm

Timber Clad Aluminium Frame:

Min width : 712mm

Max width : 1190mm

Min height : 1859mm

Max height : 2189mm

All sizes exclude Timber or PVC-U sills and extensions

If a low threshold is required please deduct 7mm from height



Satin *



Obscure *

See page 68 for all choices

Photo: The Glengarry in Dove with Clear glazing and Contemporary Brushed Stainless Steel hardware with a timber capped aluminium frame

THE RUFFORD

MF36



With its arched tongue and groove style boards, the Rufford, when paired with our Premium Heritage hardware is the picture of country charm. Alternatively, add Contemporary hardware and you can enjoy a thoroughly modern look.

22

PVC-U Frame:

Min width : 724mm	Max width : 1202mm
Min height : 1865mm	Max height : 2195mm

Timber Clad Aluminium Frame:

Min width : 712mm	Max width : 1190mm
Min height : 1859mm	Max height : 2189mm

*All sizes exclude Timber or PVC-U sills and extensions.
If a low threshold is required please deduct 7mm from height.*

Photo: The Rufford in Pebble Grey with Prairie glazing and Sweet Chrome hardware with a timber capped aluminium frame

DECORATIVE OPTIONS



1

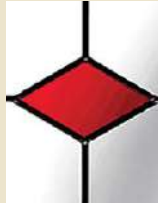

2

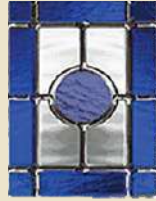

3



4

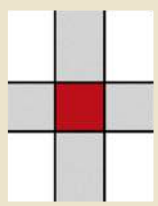

5



6



7



8



9



10

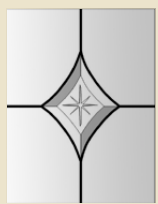

11



12



13



14

- 1. Diamond Bevel*
- 2. Diamond Red*¹
- 3. Dorchester Blue²
- 4. Reflections*
- 5. Lattice Red*³
- 6. Finesse
- 7. Flair
- 8. Diamond Cut*
- 9. Elegance
- 10. Prairie*
- 11. Crystal Diamond*
- 12. Simplicity*⁴
- 13. Satin*
- 14. Obscure⁵

*Laminate glass option available

¹Also available in Diamond Blue, Grey or Green

² Also available in Dorchester Amber or Green

³ Also available in Lattice Blue, Green or Bevel

⁴ Available in Zinc or Brass

⁵ See page 68 for all choices

Our decorative glazing designs are supplied with a choice of backing glass see page 69

THE MERCIA

MFC3



The Mercia is a classic design with its tongue and groove style boards and its diamond window. With a rich choice of glazing and a broad range of hardware, the Mercia is perfectly suited to many locations.

24

PVC-U Frame:

Min width : 724mm

Max width : 1202mm

Min height : 1865mm

Max height : 2195mm

Timber Clad Aluminium Frame:

Min width : 712mm

Max width : 1190mm

Min height : 1859mm

Max height : 2189mm

All sizes exclude Timber or PVC-U sills and extensions.

If a low threshold is required please deduct 7mm from height.

Photo: The Mercia in Pitted Olive with Murano Red glazing and Pewter Premium Heritage hardware with a timber capped aluminium frame

DECORATIVE OPTIONS

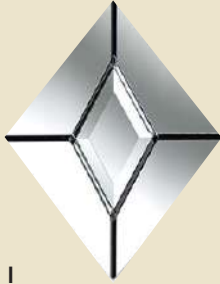

1



2

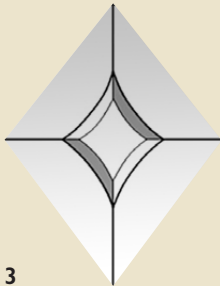

3

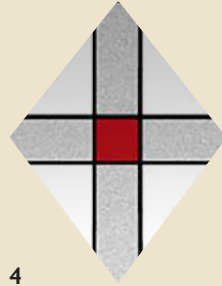

4



5

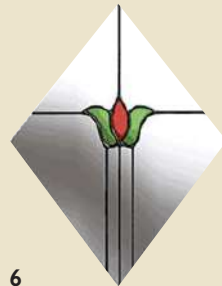

6



7



8

- 1. Diamond Bevel*
- 2. Diamond Red*¹
- 3. Crystal Diamond*
- 4. Lattice Red*²
- 5. Murano Red*³
- 6. Fleur*
- 7. Satin*
- 8. Obscure*⁴

*Laminate glass option available

¹Also available in Diamond Blue, Grey or Green

²Also available in Lattice Blue, Green or Bevel

³Also available in Murano Blue, Black, Green or Purple

⁴See page 68 for all choices

Our decorative glazing designs are supplied with a choice of backing glass see page 69

THE ROCKINGHAM

MFH9

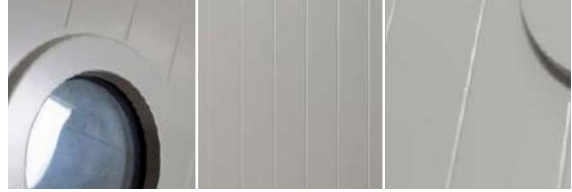

With its porthole style window and tongue and groove scratch, the Rockingham gives an air of the nautical, however, its clean crisp lines make it a popular choice across many modern homes.

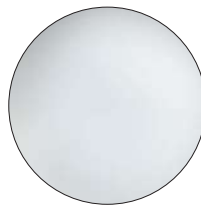

Satin *



Obscure *
See page 68 for
all choices

* Laminated glass option available

Our decorative glazing designs are supplied with a choice of backing glass see page 69

PVC-U Frame:

Min width : 724mm

Max width : 1202mm

Min height : 1865mm

Max height : 2195mm

Timber Clad Aluminium Frame:

Min width : 712mm

Max width : 1190mm

Min height : 1859mm

Max height : 2189mm

All sizes exclude Timber or PVC-U sills and extensions

If a low threshold is required please deduct 7mm from height

Photo: The Rockingham in French Sage with Obscure glazing and Contemporary Brushed Stainless Steel hardware with a timber capped aluminium frame

THE HAMPTON

MF47



Often utilised when privacy is paramount or for back door applications, the Hampton is a design classic with its grooved board style. The simple nature of its design makes it a best-selling door.

27

PVC-U Frame:

Min width : 724mm

Max width : 1202mm

Min height : 1865mm

Max height : 2195mm

Timber Clad Aluminium Frame:

Min width : 712mm

Max width : 1190mm

Min height : 1859mm

Max height : 2189mm

All sizes exclude Timber or PVC-U sills and extensions

If a low threshold is required please deduct 7mm from height

Photo: The Hampton in Chartwell with Anvil Chrome hardware and a timber capped aluminium frame

THE DALBY

MFH6

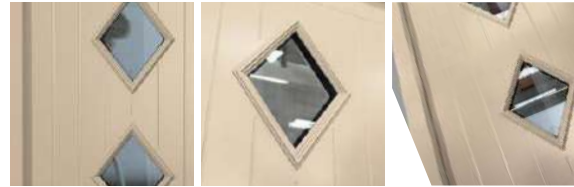

The quirky design of The Dalby makes this door a best-seller in the Craftsman range. With three large diamond apertures which can be glazed with a choice of decorative glass design, the Dalby enjoys stunning good looks.

28

PVC-U Frame:

Min width : 724mm

Max width : 1202mm

Min height : 1865mm

Max height : 2195mm

Timber Clad Aluminium Frame:

Min width : 712mm

Max width : 1190mm

Min height : 1859mm

Max height : 2189mm

All sizes exclude Timber or PVC-U sills and extensions.

If a low threshold is required please deduct 7mm from height.

Photo: The Dalby in Mannequin with Simplicity Zinc glazing and Anvil Chrome hardware with a timber capped aluminium frame

DECORATIVE OPTIONS

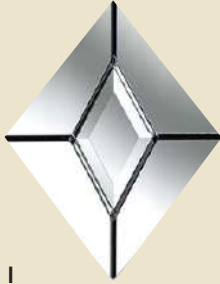

1



2

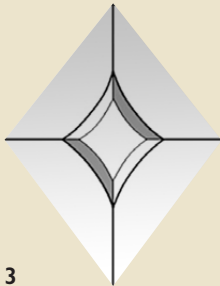

3



4



5

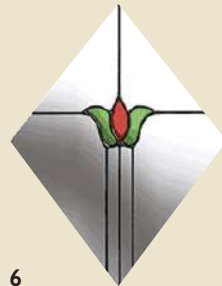

6



7

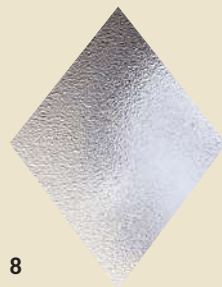

8

- 1. Diamond Bevel*
- 2. Diamond Red*¹
- 3. Crystal Diamond*
- 4. Lattice Red*²
- 5. Murano Red*³
- 6. Fleur*
- 7. Satin*
- 8. Obscure*⁴

*Laminate glass option available

¹Also available in Diamond Blue, Grey or Green

²Also available in Lattice Blue, Green or Bevel

³Also available in Murano Blue, Black, Green or Purple

⁴See page 68 for all choices

Our decorative glazing designs are supplied with a choice of backing glass see page 69

THE WENTWOOD

MFFI



An unglazed slab with full width horizontal grooves defines the Wentwood and gives it a more contemporary feel than panelled door styles. With no glass set to navigate this door style is a good canvas for hardware and door furniture.

30

PVC-U Frame:

Min width : 724mm Max width : 1202mm
Min height : 1865mm Max height : 2195mm

Timber Clad Aluminium Frame:

Min width : 712mm Max width : 1190mm
Min height : 1859mm Max height : 2189mm

All sizes exclude Timber or PVC-U sills and extensions

If a low threshold is required please deduct 7mm from height

Photo: The Wentwood in Cambridge Blue with ProLinea hardware and a timber capped aluminium frame

THE PORTLAND

MF60



The charming cottage window on the Portland stable door makes it a perfect compromise between the unglazed Heartwood and the half-glazed Charlcote. A beautiful stable door!

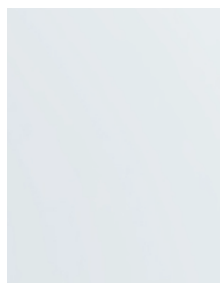

Satin *

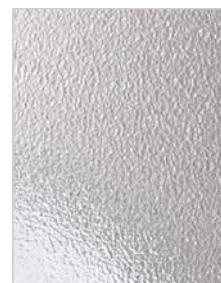

Obscure *
See page 68 for
all choices

* Laminated glass option available
Our decorative glazing designs are supplied with a choice of backing glass see page 69

Timber/PVC-U Clad Aluminium Frame:

Min width : 712mm Max width : 1190mm
Min height : 1859mm Max height : 2189mm

*All sizes exclude Timber sills and extensions
If a low threshold is required please deduct 7mm from height*

Photo: The Portland in French Sage with Satin glazing and Premium Heritage hardware in Pewter and a timber capped aluminium frame

THE CHARLCOTE

MF61



The Charlote is our most popular stable door and often used at the rear of a property. Opening the top half of the door allows ventilation whilst preventing children and pets from straying outdoors.



Satin *



Obscure *
See page 68 for
all choices

* Laminated glass option available

Our decorative glazing designs are supplied with a choice of backing glass see page 69

Timber/PVC-U Clad Aluminium Frame:

Min width : 712mm

Max width : 1190mm

Min height : 1859mm

Max height : 2189mm

All sizes exclude Timber sills and extensions

If a low threshold is required please deduct 7mm from height

Photo: The Charlote in Vellum with Satin glazing and ProLinea Black hardware and a timber capped aluminium frame

THE HEARTWOOD

MFM7



The Heartwood stable door style best demonstrates the vertical tongue and groove effect and the painted finish of the Craftsman range. This stable door provides total privacy until it is fully or half opened.

33

Timber/PVC-U Clad Aluminium Frame:

Min width : 712mm Max width : 1190mm
Min height : 1859mm Max height : 2189mm

All sizes exclude Timber sills and extensions

If a low threshold is required please deduct 7mm from height

Photo: The Heartwood in Chalk Cliff with Premium Heritage Hardware in Black and a timber capped aluminium frame

THE WHINFELL

MF6F



Based on the popular Portland, the Whinfell is an impressive looking selection. With a handsome geometric tongue and groove design, this door is both stylish and functional.



Satin *



Obscure *
See page 68 for
all choices

* Laminated glass option available

Our decorative glazing designs are supplied with a choice of backing glass see page 69

Timber/PVC-U Clad Aluminium Frame:

Min width : 712mm

Max width : 1190mm

Min height : 1859mm

Max height : 2189mm

All sizes exclude Timber sills and extensions

If a low threshold is required please deduct 7mm from height

Photo: The Whinfell in Devonshire with Satin glazing and Chrome Premium Heritage Hardware with a timber capped aluminium frame

THE WINTERFOLD

MF6G



The Winterfold stable door is a great choice for any home. Featuring a sweeping curved groove in the design, it is perfectly paired with any of our stable door hardware.



Satin *

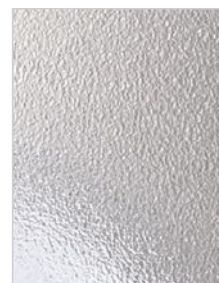

Obscure *
See page 68 for
all choices

* Laminated glass option available
Our decorative glazing designs are supplied with a choice of backing glass see page 69

Timber/PVC-U Clad Aluminium Frame:

Min width : 712mm Max width : 1190mm
Min height : 1859mm Max height : 2189mm

All sizes exclude Timber sills and extensions

If a low threshold is required please deduct 7mm from height

Photo: The Winterfold in Agate Grey with Satin glazing and Premium Heritage Hardware in Gold with a timber capped aluminium frame



OUR TRADITIONAL DOORS

WHATEVER LOOK YOU WISH TO CREATE, OUR RANGE OF ELEGANT
AND TIMELESS TRADITIONALLY STYLED DOORS WILL GIVE YOUR HOME
AN AIR OF SOPHISTICATION AND WARMTH.

37



ELEGANT LINES AND EXPERTLY CRAFTED
PANELS COMBINE WITH MODERN
CONSTRUCTION, GIVING YOU THE VERY
BEST OF BOTH WORLDS.



TRADITIONAL STYLES

YOUR FRONT DOOR IS THE FIRST IMPRESSION
THAT A VISITOR HAS OF YOUR HOME.

Whether you want to give the appearance of urban sophistication or something altogether grander, the Craftsman Traditional range has the ideal design.

from our colour palette such as Wax Seal or Bottle for a classic look or choose a natural shade such as French Sage or Vellum for a more contemporary edge.

Our traditional panels and mouldings have an elegant timeless quality that provides your home with a look of tasteful discernment. Choose one of the stronger hues

Whatever you decide, Solar Calibre Craftsman provide the choice and range to make the right impression.

- 1. The Sherwood p42
- 2. The Parkhurst p43
- 3. The Arden p44
- 4. The Marston p46
- 5. The Shackleford p48
- 6. The Highgate p49
- 7. The Ashdown p50
- 8. The Charnwood p52
- 9. The Newstead p54
- 10. The Epping p56
- 11. The Dean p58
- 12. The Galloway p59
- 13. The Hatfield p60
- 14. The Silverhill p61
- 15. The Kensington p62





CRAFTSMAN

A CLASS LEADER IN
STRENGTH, SECURITY
AND AUTHENTIC
CRAFTSMANSHIP.



THE SHERWOOD

MFD5



An interesting play on the traditional dual glazed door, the Sherwood gives maximum light through its triple apertures. Choose from Clear, Satin or one of our four Obscure options.



Satin*

Obscure*

See page 68 for all choices

*Laminate glass option available

Our decorative glazing designs are supplied with a choice of backing glass see page 69

PVC-U Frame:

Min width : 877mm

Max width : 1202mm

Min height : 1980mm

Max height : 2195mm

Timber Clad Aluminium Frame:

Min width : 865mm

Max width : 1202mm

Min height : 1975mm

Max height : 2195mm

All sizes exclude Timber or PVC-U sills and extensions

If a low threshold is required please deduct 7mm from height

Photo: The Sherwood in Bournville with Satin glazing and ProLinea Polished Chrome hardware

THE PARKHURST

MF23



A stunning addition to the Solar Calibre Craftsman range, the Parkhurst has the classic timeless looks of the 1930's and 40's, with the myriad of benefits of a modern timber engineered door.

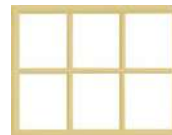

Georgian
Fretwork*

Available in door
colour with
Satin, Obscure or
Clear glass

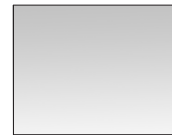

Satin*



Obscure*

See page 68
for all choices

*Laminate glass option available

Our decorative glazing designs are supplied with a
choice of backing glass see page 69

PVC-U Frame:

Min width : 837mm

Max width : 1202mm

Min height : 1935mm

Max height : 2195mm

Timber Clad Aluminium Frame:

Min width : 825mm

Max width : 11909mm

Min height : 1929mm

Max height : 2189mm

All sizes exclude Timber sills and extensions

If a low threshold is required please deduct 7mm from height

Photo: The Parkhurst in Lemon Curd with Clear glazing
and ProLinea Polished Gold hardware

THE ARDEN

MF11



The Arden is a traditional 6 panel door with two high level lights that may be glazed with a choice of one of our decorative glass options. A classic look for older homes or just as good on a modern dwelling.

44

PVC-U Frame:

Min width : 837mm

Max width : 1202mm

Min height : 1935mm

Max height : 2195mm

Timber Clad Aluminium Frame:

Min width : 712mm

Max width : 1190mm

Min height : 1859mm

Max height : 2189mm

All sizes exclude Timber or PVC-U sills and extensions.

If a low threshold is required please deduct 7mm from height.

Photo: The Arden in Summer Coral with Prairie glazing and ProLinea Polished Gold hardware

DECORATIVE OPTIONS



1



2



3



1. Diamond Bevel*
2. Diamond Red*¹
3. Lattice Red*²
4. Murano Red*³
5. Dorchester Blue⁴
6. Fleur*
7. Reflections*
8. Simplicity⁵
9. Prairie*
10. Finesse
11. Diamond Cut*⁶
12. Flair
13. Crystal Diamond*
14. Elegance*
15. Satin*
16. Obscure*⁶

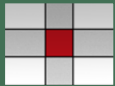

5



7



9

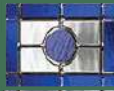

11



*Laminate glass option available



13



15



¹Also available in Diamond Blue, Grey or Green

²Also available in Lattice Blue, Green or Bevel

³Also available in Murano Blue, Black, Green or Purple

⁴Also available in Dorchester Amber or Green

⁵Available in Zinc or Brass (Zinc in lam only)

⁶See page 68 for all choices

Our decorative glazing designs are supplied with a choice of backing glass see page 69



17



19



21



23

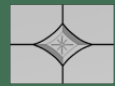

25

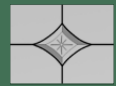

27



29



31



THE MARSTON

MF03



The Marston is our ever popular half glazed door. Allowing light to flood into the room beyond, this stunning door may also be personalised with a decorative glazing panel of your choice.

46

PVC-U Frame:

Min width : 877mm

Max width : 1202mm

Min height : 1935mm

Max height : 2195mm

Timber Clad Aluminium Frame:

Min width : 865mm

Max width : 1190mm

Min height : 1929mm

Max height : 2189mm

All sizes exclude Timber or PVC-U sills and extensions.

If a low threshold is required please deduct 7mm from height.

Photo: The Marston in Peacock with Satin glazing and Sweet Gold hardware

DECORATIVE OPTIONS

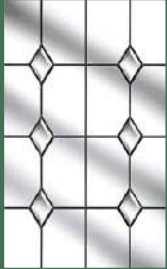

1

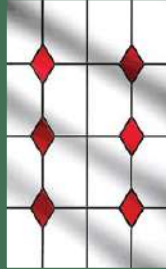

2

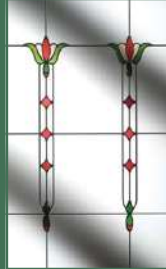

3



4

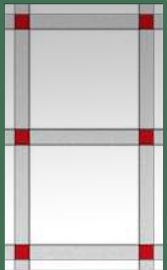

5



6



7

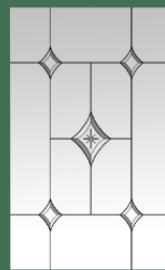

8



9



10



11

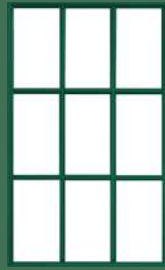

12



13



14



15

- 1. Diamond Bevel*
- 2. Diamond Red*¹
- 3. Fleur*
- 4. Murano Red*²
- 5. Lattice Red*³
- 6. Diamond Cut*
- 7. Reflections*
- 8. Crystal Diamond*
- 9. Elegance*
- 10. Simplicity Zinc*
- 11. Prairie*
- 12. Georgian Fretwork*⁴
- 13. Northumberland Fretwork*⁵
- 14. Satin*
- 15. Obscure*⁶

*Laminate glass option available

¹Also available in Diamond Blue, Grey or Green

² Also available in Murano Blue, Black, Green or Purple

³ Also available in Lattice Blue, Green or Bevel

⁴ Available in door colour with Satin, Obscure or Clear glass

⁵ Available in door colour with Satin, Obscure or Clear glass

⁶ See page 68 for all choices

Our decorative glazing designs are supplied with a choice of backing glass see page 69

THE SHACKLEFORD

MF85



The faux split scratch design of the Shackleford gives the impression of a traditional narrow double door found on many fashionable town-houses without any of the impracticalities.

48

PVC-U Frame:

Min width : 837mm Max width : 1202mm
Min height : 1935mm Max height : 2195mm

Timber Clad Aluminium Frame:

Min width : 825mm Max width : 1190mm
Min height : 1929mm Max height : 2189mm

All sizes exclude Timber or PVC-U sills and extensions

If a low threshold is required please deduct 7mm from height

Photo: The Shackleford in Merlot with Premium Heritage hardware in Pewter and a timber capped aluminium frame

THE HIGHGATE

MFM2



A true design classic that gives any home a grand appearance, the Highgate, teamed with our beautiful high end door furniture is a favourite for many older properties in town and country.

49

PVC-U Frame:

Min width : 837mm

Max width : 1202mm

Min height : 1935mm

Max height : 2195mm

Timber Clad Aluminium Frame:

Min width : 825mm

Max width : 1190mm

Min height : 1929mm

Max height : 2189mm

All sizes exclude Timber sills and extensions

If a low threshold is required please deduct 7mm from height

Photo: The Highgate in Wax Seal with Premium Heritage hardware in Pewter and a timber capped aluminium frame

THE ASHDOWN

MF15



The Ashdown is the classic dual glazed option making a smart statement for your home. Choose from our wide range of decorative glazing options to add an additional personal touch.

50

PVC-U Frame:

Min width : 877mm Max width : 1202mm
Min height : 1935mm Max height : 2195mm

Timber Clad Aluminium Frame:

Min width : 865mm Max width : 1190mm
Min height : 1929mm Max height : 2189mm

*All sizes exclude Timber or PVC-U sills and extensions.
If a low threshold is required please deduct 7mm from height.*

Photo: The Ashdown in Cambridge Blue with Elegance glazing, ProLinea Satin Silver hardware and a timber capped aluminium frame

DECORATIVE OPTIONS

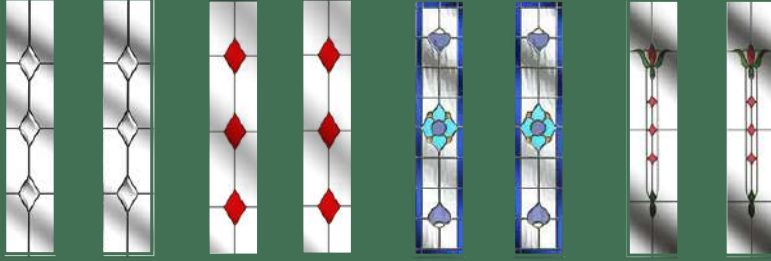

1

2

3

4

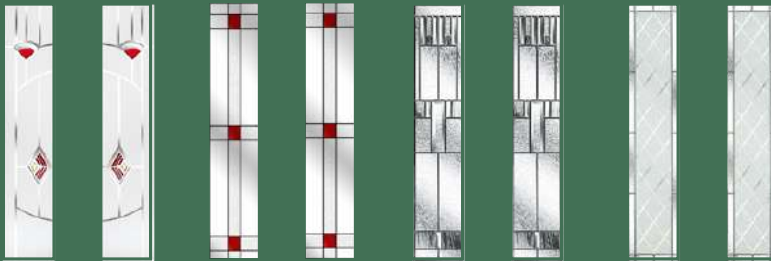

5

6

7

8

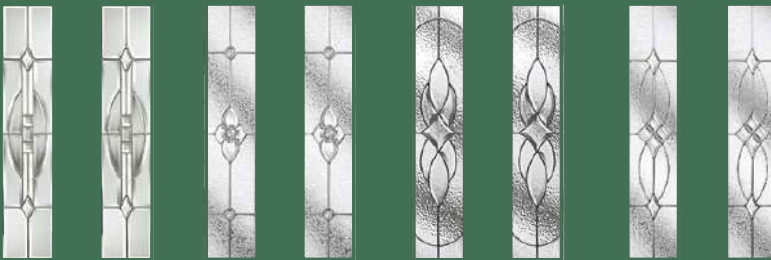

9

10

11

12

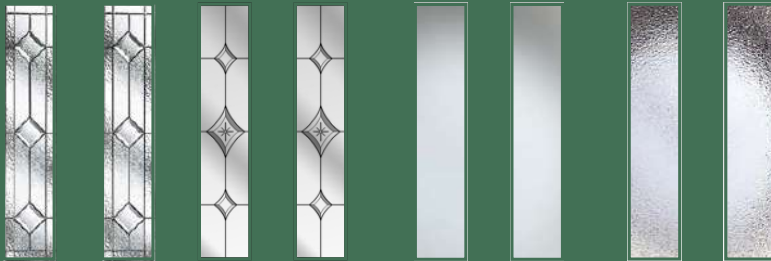

13

14

15

16

- 1. Diamond Bevel*
- 2. Diamond Red*¹
- 3. Dorchester Blue²
- 4. Fleur*
- 5. Murano Red*³
- 6. Lattice Red*⁴
- 7. Prairie*
- 8. Diamond Cut*
- 9. Reflections*
- 10. Finesse
- 11. Elegance*
- 12. Flair
- 13. Simplicity*⁵
- 14. Crystal Diamond*
- 15. Satin*
- 16. Obscure*⁶

*Laminate glass option available

¹Also available in Diamond Blue, Grey or Green

²Also available in Dorchester Amber or Green

³Also available in Murano Blue, Black, Green or Purple

⁴Also available in Lattice Blue, Green or Bevel

⁵Available in Zinc or Brass (Zinc in lam only)

⁶See page 68 for all choices

Our decorative glazing designs are supplied with a choice of backing glass see page 69

THE CHARNWOOD

MFA3



With a half moon top panel and dual rectangular side panels, the Charnwood is a highly decorative door with a host of stunning glazing options to suit.

Please note: All decorative glass is available for the 44mm door style only; the clear, obscure, satin and Georgian glass styles are available for the 54mm door style only.

52

PVC-U Frame:

Min width : 877mm	Max width : 1202mm
Min height : 1935mm	Max height : 2195mm

Timber Clad Aluminium Frame:

Min width : 865mm	Max width : 1190mm
Min height : 1929mm	Max height : 2189mm

*All sizes exclude Timber or PVC-U sills and extensions.
If a low threshold is required please deduct 7mm from height.*

Photo: The Charnwood in Savile Row with ProLinea Polished Gold furniture and Dorchester Blue glazing and a timber capped aluminium frame

DECORATIVE OPTIONS

All decorative glass is available for the 44mm door style only



1

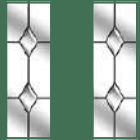

2

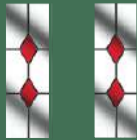

3

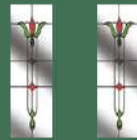

1. Diamond Bevel*
2. Diamond Red*¹
3. Fleur*
4. Murano Red*²
5. Dorchester Blue³
6. Flair
7. Finesse
8. Prairie*
9. Simplicity⁴
10. Elegance*
11. Crystal Diamond*
12. Diamond Cut*
13. Reflections*
14. Satin*⁵
15. Obscure*⁶

*Laminate glass option available

¹Also available in Diamond Blue, Grey or Green

²Also available in Murano Blue, Black, Green or Purple

³Also available in Dorchester Amber or Green

⁴Available in Zinc or Brass

⁵54mm door only.

⁶54mm door only. See page 68 for all choices

Our decorative glazing designs are supplied with a choice of backing glass see page 69



4



5

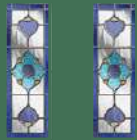

6

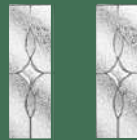

7

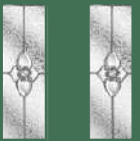

8

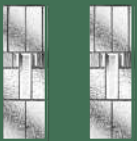

9



10

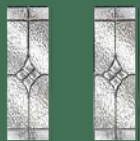

11

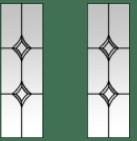

12



13

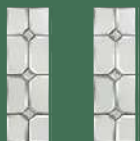

14



15



THE NEWSTEAD

MF04



The Newstead is a half glazed door with a twist. Allowing as much light to flood in as the ever popular Marston, this stunning door enjoys an unusual triple panel design below.

54

PVC-U Frame:

Min width : 877mm	Max width : 1202mm
Min height : 1935mm	Max height : 2195mm

Timber Clad Aluminium Frame:

Min width : 865mm	Max width : 1190mm
Min height : 1929mm	Max height : 2189mm

*All sizes exclude Timber or PVC-U sills and extensions.
If a low threshold is required please deduct 7mm from height.*

Photo: The Newstead in Chalk Cliff with Fleur glazing and Satin Silver ProLinea Hardware and a timber capped aluminium frame

DECORATIVE OPTIONS

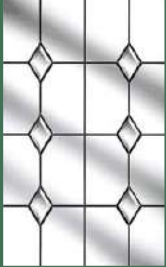

1

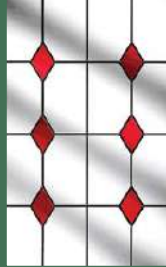

2

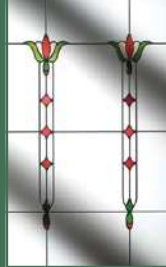

3



4

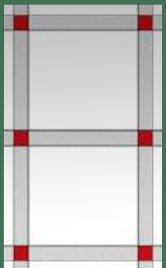

5



6



7

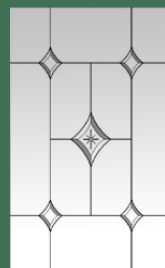

8



9



10



11

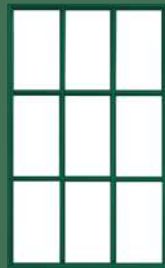

12



13



14



15

1. Diamond Bevel*
2. Diamond Red*¹
3. Fleur*
4. Murano Red*²
5. Lattice Red*³
6. Diamond Cut*
7. Reflections*
8. Crystal Diamond*
9. Elegance*
10. Simplicity Zinc*
11. Prairie*
12. Georgian Fretwork*⁴
13. Northumberland Bar*⁵
14. Satin*
15. Obscure*⁶

*Laminate glass option available

¹Also available in Diamond Blue, Grey or Green

² Also available in Murano Blue, Black, Green or Purple

³ Also available in Lattice Blue, Green or Bevel

⁴ Available in door colour with Satin, Obscure or Clear glass

⁵ Available in door colour with Satin, Obscure or Clear glass

⁶ See page 68 for all choices

Our decorative glazing designs are supplied with a choice of backing glass see page 69

THE EPPING

MF14



The Epping teams elegant lines with charming glazing panels ideal for allowing light in and providing you with the opportunity to personalise your home.

56

PVC-U Frame:

Min width : 877mm Max width : 1202mm
Min height : 1935mm Max height : 2195mm

Timber Clad Aluminium Frame:

Min width : 865mm Max width : 1190mm
Min height : 1929mm Max height : 2189mm

*All sizes exclude Timber or PVC-U sills and extensions.
If a low threshold is required please deduct 7mm from height.*

Photo: The Epping in Agate Grey with Simplicity Zinc glazing and Polished Gold ProLinea hardware with a timber capped aluminium frame

DECORATIVE OPTIONS

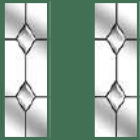

1

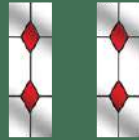

2

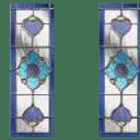

3



4



5



6

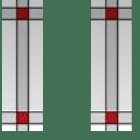

7

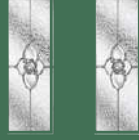

8

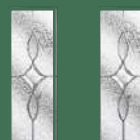

9



10

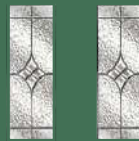

11

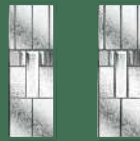

12



13

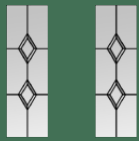

14



15



16

- 1. Diamond Bevel*
- 2. Diamond Red*¹
- 3. Dorchester Blue²
- 4. Fleur*
- 5. Murano Red*
- 6. Reflections
- 7. Lattice Red*
- 8. Finesse
- 9. Flair
- 10. Diamond Cut*
- 11. Elegance
- 12. Prairie*
- 13. Simplicity Zinc
- 14. Crystal Diamond*
- 15. Satin*
- 16. Obscure*¹

*Laminate glass option available

¹See page 68 for all choices

Our decorative glazing designs are supplied with a choice of backing glass see page 69

THE DEAN

MF07



The Dean is a smart four panel door with a traditional town-house appearance that looks equally at home on an older property or a more contemporary dwelling.

58

PVC-U Frame:

Min width : 837mm	Max width : 1202mm
Min height : 1935mm	Max height : 2195mm

Timber Clad Aluminium Frame:

Min width : 825mm	Max width : 1190mm
Min height : 1929mm	Max height : 2189mm

All sizes exclude Timber or PVC-U sills and extensions

If a low threshold is required please deduct 7mm from height

Photo: The Dean in Whitby Jet with Satin Silver ProLinea hardware and a timber capped aluminium frame

THE GALLOWAY

MF08



The Galloway is a traditional six panelled door suited to most homes. Whether you are choosing a door for a new build property or a classic town-house, the Galloway is a perfect choice.

59

PVC-U Frame:

Min width : 837mm Max width : 1202mm
Min height : 1935mm Max height : 2195mm

Timber Clad Aluminium Frame:

Min width : 825mm Max width : 1190mm
Min height : 1929mm Max height : 2189mm

All sizes exclude Timber sills and extensions

If a low threshold is required please deduct 7mm from height

Photo: The Galloway in Devonshire with Polished Chrome ProLinea hardware and a timber capped aluminium frame

THE HATFIELD

MFM3



The triple apertures of the Hatfield allows for a choice of Satin, Clear or Obscure glass designs that will provide a contemporary look to the entrance of your home.

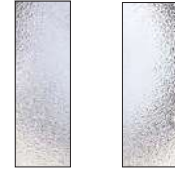
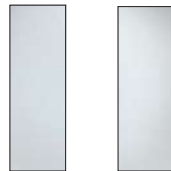

Satin

Obscure
See page 68 for
all choices

PVC-U Frame:

Min width : 877mm

Max width : 1202mm

Min height : 1935mm

Max height : 2195mm

Timber Clad Aluminium Frame:

Min width : 825mm

Max width : 1190mm

Min height : 1929mm

Max height : 2189mm

All sizes exclude Timber or PVC-U sills and extensions

If a low threshold is required please deduct 7mm from height

Photo: The Hatfield in Mulberry with Obscure glazing and ProLinea Satin hardware and a timber capped aluminium frame

THE SILVERHILL

MF5



The Silverhill is based on a similar design to the Parkhurst, a classic timeless look of the 1930's and 40's, however the Silverhill, with its beautiful arched window has a charm of its own.



Georgian
Fretwork*
Available in door
colour with
Satin, Obscure or
Clear glass



Satin*



Obscure*
See page 68
for all choices

*Laminate glass option available
Our decorative glazing designs are supplied with a
choice of backing glass see page 69

PVC-U Frame:

Min width : 837mm Max width : 1202mm
Min height : 1935mm Max height : 2195mm

Timber Clad Aluminium Frame:

Min width : 825mm Max width : 1190mm
Min height : 1929mm Max height : 2189mm

*All sizes exclude Timber sills and extensions
If a low threshold is required please deduct 7mm from height*

Photo: The Silverhill in Bottle with Obscure glazing and
Painted Heritage Brass hardware and a timber capped
aluminium frame

THE KENSINGTON

MFM5(K)



The Kensington is a treasured member of the Craftsman family. This gorgeous design is defined by its elegant arched window and striking sculpted features.



Georgian
Fretwork*
Available in door
colour with
Satin, Obscure or
Clear glass



Satin*



Obscure*
See page 68
for all choices

*Laminate glass option available
Our decorative glazing designs are supplied with a
choice of backing glass see page 69

PVC-U Frame:

Min width : 837mm Max width : 1202mm
Min height : 1935mm Max height : 2195mm

Timber Clad Aluminium Frame:

Min width : 825mm Max width : 1190mm
Min height : 1929mm Max height : 2189mm

*All sizes exclude Timber or PVC-U sills and extensions
If a low threshold is required please deduct 7mm from height*

Photo: The Kensington in Lemon Curd with Satin
glazing and Premium Heritage Pewter hardware with a
timber capped aluminium frame





CRAFT YOUR PERFECT DOOR

OUR RANGE HAS OVER 24 COLOUR SHADES TO CHOOSE FROM - INCLUDING A WIDE RANGE OF PANELS, SIDELIGHT AND HARDWARE OPTIONS ALL DESIGNED FOR YOU TO CREATE A FRONT DOOR WITH A TOUCH OF INDIVIDUALITY.

65

TO HELP YOU CRAFT YOUR OWN INDIVIDUAL DOOR, LET US HELP YOU FIND YOUR NEAREST CRAFTSMAN STOCKIST BY CALLING US ON:

01623 275030

OR ALTERNATIVELY EMAIL US:

info@solarcalibre.co.uk

COLOUR

DOOR COLOUR

From soft natural hues to stronger traditional colours, our colour palette offers 24 shades to give your door a unique look. To guarantee your Craftsman door is protected, every door leaves us with two water based layers of colour, two of undercoat and a primer - the equivalent of 10 coats of paint.

WAX SEAL BS04D45	SUMMER CORAL* BS04D45	LEMON CURD* BS04D45	PITTED OLIVE BS04D45
BOTTLE BS14C39	CHARTWELL BS14C35	PEACOCK RAL 5020	CAMBRIDGE BLUE*
DEVONSHIRE*	SAVILE ROW BS20C40	MULBERRY*	MERLOT* BS04D45
BOURNVILLE RAL 8016	MANNEQUIN*	POTTER'S WHEEL*	FRENCH SAGE
VELLUM	CHALK CLIFF	DOVE RAL 7035	PEBBLE GREY RAL 7032
AGATE GREY RAL 7038	SMOKESTACK RAL 7037	ANTHRACITE RAL 7016	WHITBY JET RAL 9005

Colours are representative only.
 * Paint mixed in-house.

Please note that all doors are the same colour internally as the external colour unless specified otherwise at the time of ordering.

DECORATIVE PANEL & GLAZING

PANEL STYLE

The Solar Calibre Craftsman range is available with a full range of sidelights, toplights and panel options, helping to create the perfect entrance. Frame extenders, and a range of sills and threshold options are also available. This versatility enables us to match the individual requirements of each installation, to create beautiful entrance ways that are also practical. Contact us for more information or a quote.

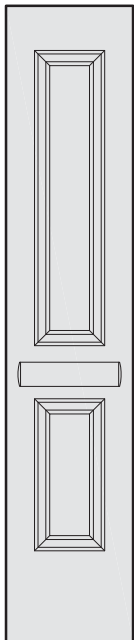

Style A
Ideal for:
The Ashdown
The Dean
The Marston

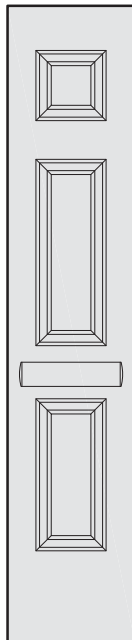

Style B
Ideal for:
The Galloway
The Epping
The Arden
The Shackleford

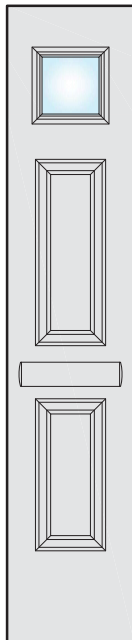

Style C
Ideal for:
The Galloway
The Epping
The Arden
The Shackleford

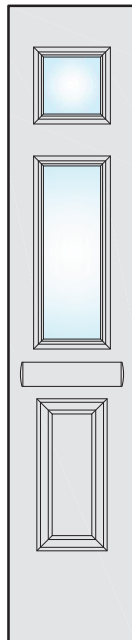

Style D
Ideal for:
The Galloway
The Epping
The Arden
The Shackleford
The Hatfield

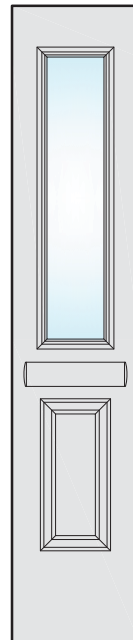

Style E
Ideal for:
The Ashdown
The Dean
The Marston

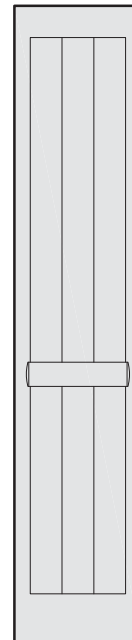

Style F
Ideal for:
The Hampton
The Mercia
The Rockingham
The Portland
The Charlcote
The Heartwood

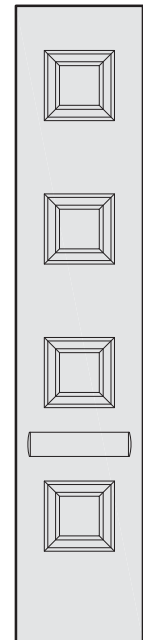

Style G
Ideal for:
The Highgate

GLAZING

We have selected the most popular glazing options best suited to your Craftsman door. From contemporary designs to the more traditional glass styles, we know you will find the perfect look for your chosen application. Although not available in every door style, the following images give an indication of appearance.



Diamond Bevel*



Diamond Red*



Diamond Blue*



Diamond Green*



Diamond Grey*



Simplicity Zinc*



Reflections*



Murano Blue*



Murano Black*



Murano Green*



Murano Purple*



Murano Red*



Finesse



Flair

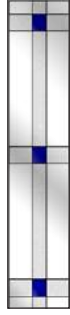

Lattice Blue *

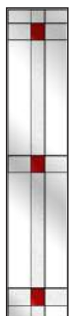
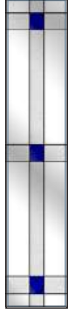

Lattice Red *

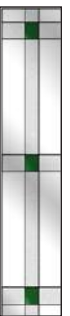
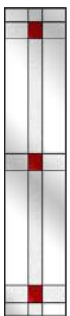

Lattice Green *



Lattice Bevel *



Diamond Cut*



Crystal Diamond*





Elegance



Dorchester Amber



Dorchester Blue



Dorchester Green



Fleur*



Prairie*



Satin*



Obscure*



*Laminate glass option available

Our decorative glazing designs are supplied with a choice of backing glass see below.

BACKING GLASS OPTIONS

10
YEAR

STANDARD SELECTION



Pilkington Stippolyte™



Pilkington Cotswold™



Pilkington Contora™



Pilkington Minster™

LOW E, ENERGY EFFICIENT GLAZING



Glazing in a Craftsman door will always reduce its thermal efficiency, but by installing our Low E option wherever possible, we can help negate that effect, which is better for the environment and better for your pocket.



Guarantee against glass unit failure



Mechanical guarantee

GLAZING COMBINATIONS

The Solar Calibre Craftsman range is available with a full range of sidelights, toplights and panel options, helping to create the perfect entrance. Frame extenders, and a range of sills and threshold options are also available. This versatility enables us to match the individual requirements of each installation, to create beautiful entrance ways that are also practical. Contact us for more information or a quote.

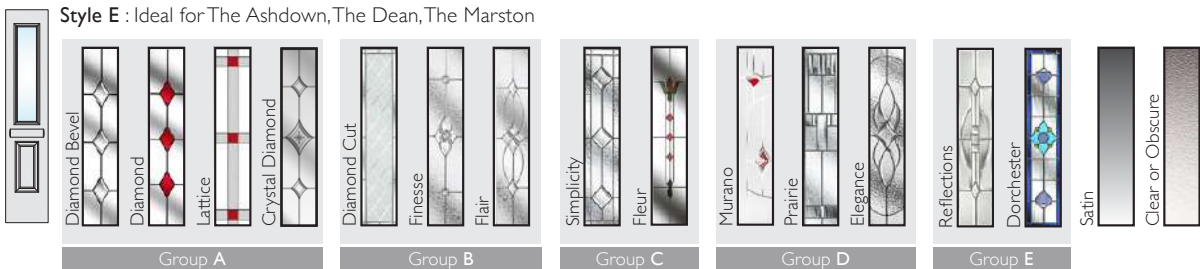
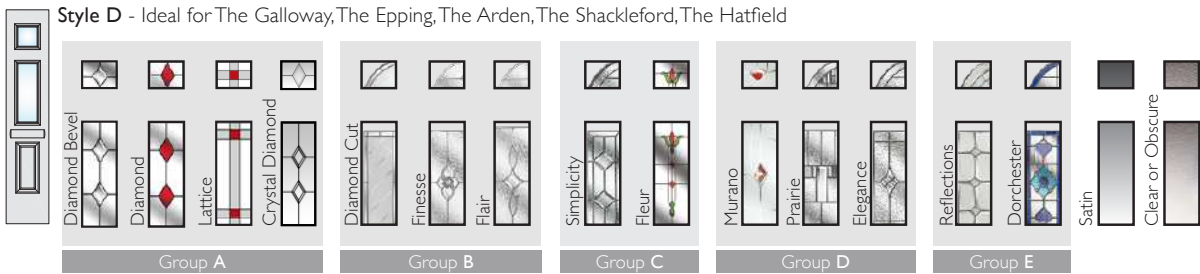
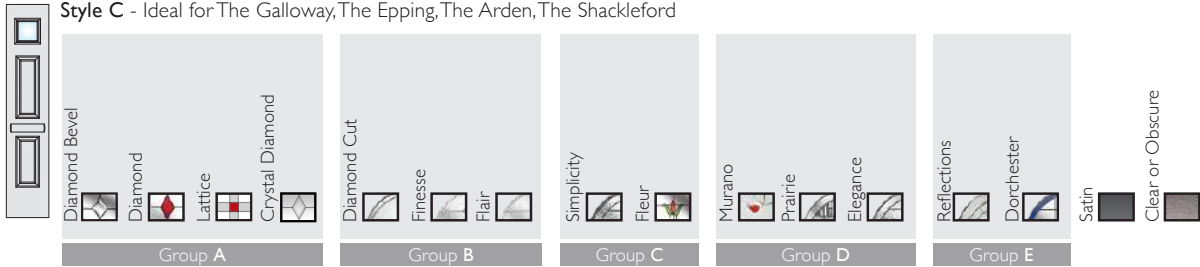

Side Panel Style	Minimum Width with Letter Plate	Minimum Width with No Letter Plate	Maximum Width	Minimum Height	Maximum Height
Style A	495mm	391mm	707mm	1865mm	2195mm
Style B	495mm	391mm	707mm	1865mm	2195mm
Style C	495mm	430mm	707mm	1865mm	2195mm
Style D	495mm	430mm	707mm	1865mm	2195mm
Style E	495mm	430mm	707mm	1865mm	2195mm
Style F	495mm	210mm	707mm	1865mm	2195mm
Style G	495mm	391mm	707mm	1865mm	2195mm

PVC-U TOPLIGHT & SIDELIGHT

Our stunning PVC-U sidelight and toplight combinations allow sunlight to flood into your home. Available in 6 frame colours (see below), these options will compliment your Craftsman door perfectly. Please note: all PVC-U sidelights are separate frames.

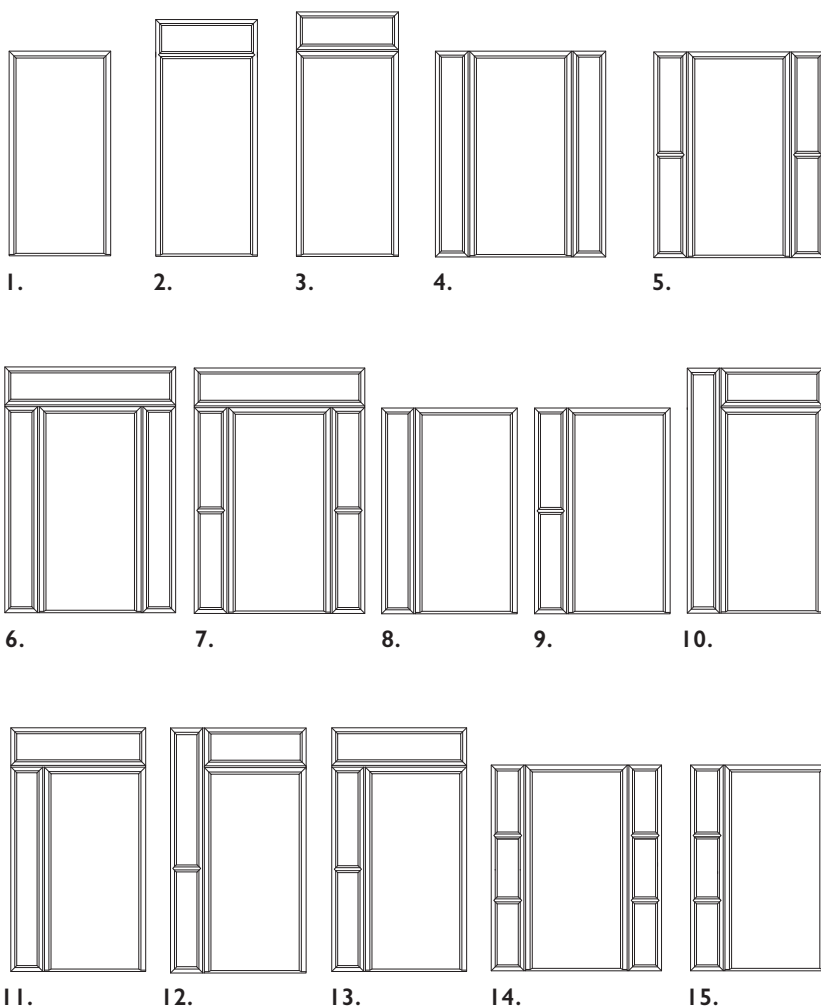

1. Single (Standard)
2. Toplight (Integrated)
3. Toplight (Separate)
4. Double sidelights
5. Double sidelights with midrails
6. Double sidelights with toplight
7. Double sidelights with toplight and midrails
8. Sidelight
9. Sidelight with midrail
10. Extended sidelight with toplight
11. Extended sidelight with toplight and midrail
12. Sidelight with toplight
13. Sidelight with toplight and midrail
14. Double sidelights with two midrails
15. Sidelight with two midrails

PVC-U Sidelights

Min width: 254mm
 Max width: 1314mm
 Max height: 2100mm

Separate sidelights are measured from edge of frame to edge of transom

PVC-U FRAME COLOUR



*Grained foils

TIMBER CLAD ALUMINIUM TOPLIGHT & SIDELIGHT

To complement your precision engineered timber doors, you may select a Timber Clad Aluminium toplight, sidelight combination. Painted in the same colour as your door, your chosen combination will be sure to make a stunning addition to your home. Please note: all Timber Clad Aluminium sidelights are integrated frames unless otherwise stated.

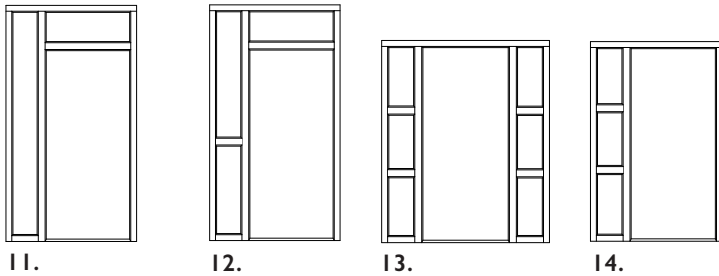
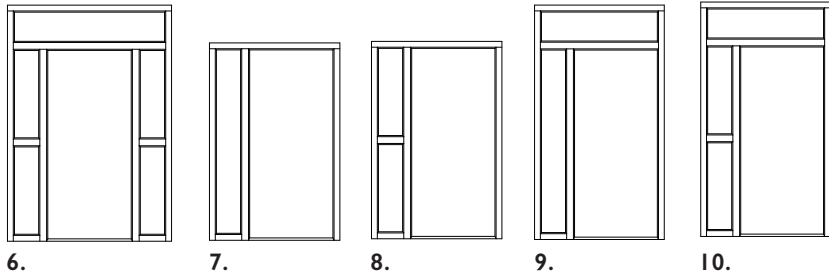
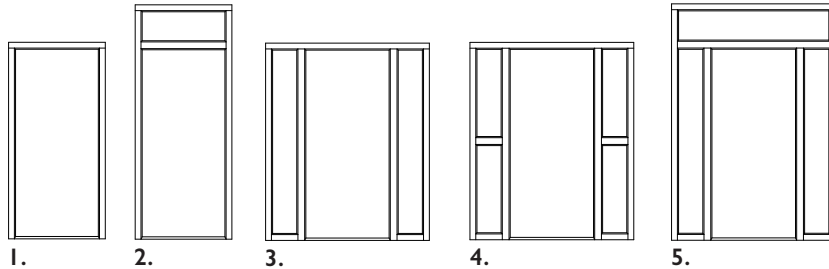

1. Single
2. Toplight
3. Double sidelights
4. Double sidelights with midrails
5. Double sidelights with toplight
6. Double sidelights with toplight and midrails
7. Sidelight
8. Sidelight with midrail
9. Extended sidelight with toplight
10. Extended sidelight with toplight and midrail
11. Sidelight with toplight
12. Sidelight with toplight and midrail
13. Double sidelights with two midrails
14. Sidelight with two midrails

Capped Aluminium Sidelights

Minimum width 230mm
 Maximum width 1290mm
 Maximum height 2190mm

Integrated sidelights are measured from edge of frame to centre of transom

TIMBER FRAME COLOUR - TO MATCH DOOR COLOUR

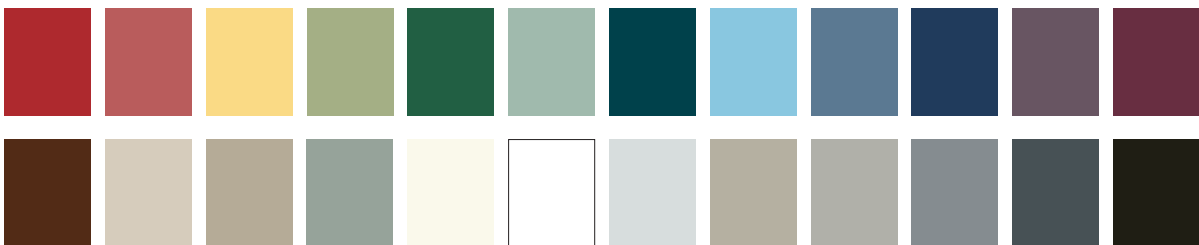

See page 73 for details

FOR EXTRA PEACE OF MIND AND ADDED SECURITY

SECURED BY DESIGN (SBD) IS THE OFFICIAL POLICE SECURITY INITIATIVE THAT WORKS TO IMPROVE THE SECURITY OF BUILDINGS AND THEIR IMMEDIATE SURROUNDINGS TO PROVIDE SAFE PLACES TO LIVE, WORK, SHOP AND VISIT

SBD's product based accreditation scheme – the Police Preferred Specification - provides a recognised standard for all security products that can deter and reduce crime.



TO UPGRADE YOUR DOOR TO A SECURED BY DESIGN DOOR YOU WILL NEED TO SELECT THE FOLLOWING OPTIONS:

1. 3 star cylinder
2. Secured by design letterbox upgrade
3. Security Chain
4. 6.8mm Laminated Glass
5. Spy Hole (Unless clear vision panel selected)

The following pages outline the choices available to ensure your door is as secure as possible.



1.



3.



2.



4.



5.

HARDWARE

STANDARD HARDWARE

Available in Polished Chrome, Polished Gold, Satin Silver and Black.

DOOR HANDLES ● ● ● ●



1.



2.



1. ProLinea lever/lever handle
2. ProLinea lever/pad handle

WINKHAUS MULTI-POINT LOCK ●



Multi-point locking system

YALE 3 STAR CYLINDER ●

(see page 59)



Kite-marked, anti-bump, anti-snap Euro cylinder

SOLAR CALIBRE HINGES ● ●



Four stainless steel/brass hinges with fixing position through hinge.

PRO-STYLE LETTERBOX ● ● ● ●



● 10 year mechanical guarantee

● 10 year surface finish powder coated guarantee

● 5 year surface finish plated guarantee

PROLINEA DOOR KNOCKERS ● ● ●



OPTIONAL EXTRAS

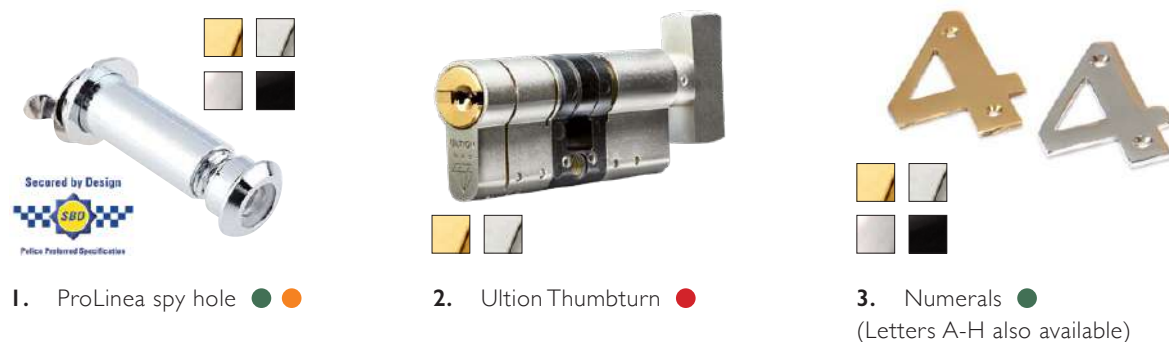

SECURED BY DESIGN LETTERBOX UPGRADE

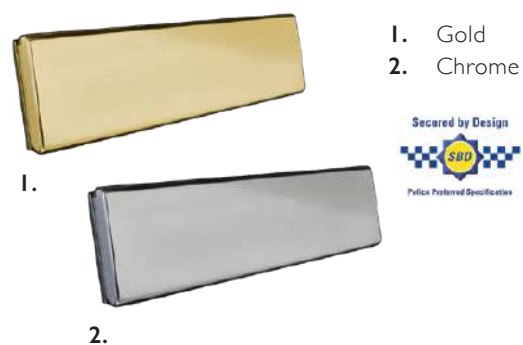

SECURITY CHAIN



Please note: As part of our continued development programme, our standard hardware specification may change without prior notice

PREMIUM HERITAGE HARDWARE

Crafted from the anvil.

DOOR HANDLES AND PULLS ●

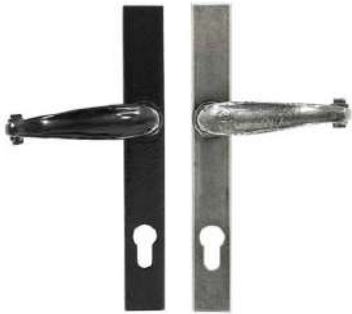

1.



2.



3.



4.



5.

- 1. Lever door handle - Cottage
- 2. Lever door handle - Avon
- 3. Lever door handle - Gothic
- 4. Octagonal centre door pull
- 5. Art Deco centre door pull

KNOCKERS ●



1.



2.



3.



4.

- 1. Door Knocker - Pear ●
- 2. Door Knocker - Loop ●
- 3. Door Knocker - Shakespeare ●
- 4. Art Deco Door Knocker

LETTERBOX ●



ESCUTCHEON ●



PREMIUM BRASS AND CHROME HARDWARE

Crafted from the anvil.

DOOR HANDLES AND PULLS ●



1.



2.

1. Reeded lever door handle
2. Art Deco centre door pull

LETTERBOX ●



KNOCKERS ●



1.



2.

ESCUTCHEON



3.

1. Doctors Door Knocker
2. Door Knocker - Loop
3. Art Deco Door Knocker

● 5 year surface finish plated guarantee

CONTEMPORARY BRUSHED STAINLESS STEEL HARDWARE

Crafted from the anvil.

DOOR HANDLES ●

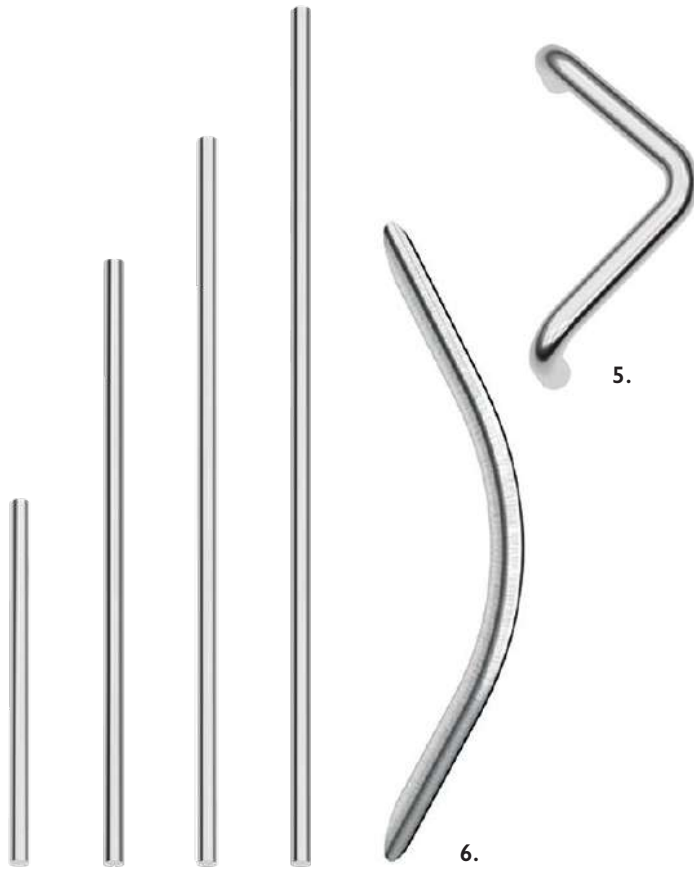

- 1.
- 2.
- 3.
- 4.

Bar Handles - off set available
(Handle options available both sides - pull escutcheon required if handle fitted externally only)

1. Bar Handle 600mm
2. Bar Handle 1000mm
3. Bar Handle 1200mm
4. Bar Handle 1400mm
5. V Handle
6. Bow Handle

CENTRE DOOR PULL ●



(external only)

KNOCKERS ●



- 1.
- 2.

1. Pony Tail
2. Ingot

LETTERPLATE ●



Brushed Stainless Steel finish

ESCUTCHEONS ●



- 1.
- 2.
- 3.
- 4.

1. Standard
2. Standard with Pull
3. Security
4. Security with Pull

● 10 year mechanical guarantee

● 10 year surface finish powder coated guarantee

● 5 year surface finish plated guarantee

PREMIUM HERITAGE STABLE DOOR HARDWARE

Crafted from the anvil

BLACK AND PEWTER DOOR HANDLES ●



1. Lever door handle - Cottage



2. Lever door handle - Avon



3. Lever door handle - Gothic

GOLD & CHROME DOOR HANDLES



Lever door handle

WINKHAUS LOCK ●



Multi-point locking system

SLIDING BOLT ●



ESCUTCHEONS ●



STANDARD STABLE DOOR HARDWARE

(Available in Polished Chrome, Polished Gold, Satin Silver and Black)

Please note that, as standard, our Stable Doors come with ProLinea handles, a pair of escutcheons and a KFV Lock. If the Premium Heritage Hardware is required then you will need to order Premium Heritage hardware: handles and a sliding bolt. The Winkhaus lock comes as standard with the Premium Heritage hardware.

PROLINEA LEVER/ LEVER HANDLE ● ● ●



ESCUTCHEONS ●

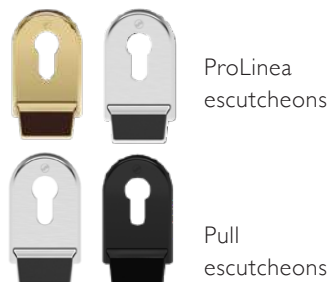

KFV LOCK ●



● 10 year mechanical guarantee

● 10 year surface finish powder coated guarantee

● 5 year surface finish plated guarantee

HARDWARE UPGRADES

ULTION

USING UNIQUELY PATENTED SNAP SECURE TECHNOLOGY, ULTION IS ANTI-SNAP, PICK, DRILL AND BUMP RESISTANT, AND IS EASY TO FIT WITH NO ADDITIONAL PREP AND NO NEED FOR CYLINDER GUARDS OR SECURITY HANDLES.

Ultion is 3 star rated straight out of the box, with a lock down mode that activates an attack lock directly into the central cam, keeping an intruder out whilst still being unlockable from the inside - keeping homes and families safe.

Ultion locks are continuously tested; having passed the Sold Secure Diamond Test, it has not yet been beaten. And with the attack lock being housed in Molybdenum, one of the best superalloys in use today, it's little wonder that Ultion has been described as having transformed the door market.



bsi.



THE £1,000 ULTION SNAP GUARANTEE

Ultion are offering a FREE 10 year guarantee to homeowners - just register at www.ultion-lock.co.uk within 28 days of installation, and if your home gets burgled as a result of your Ultion lock getting snapped in the following 10 years, you will receive £1,000.

HARDWARE UPGRADES

UNIQUE FEATURES



Over 294,000 combinations produced by 11 pins



Double anti-snap protection, with 6 hardened steel rods and two plates in both ends



3 Star TS007 Test rating, Sold Secure Diamond rating



Thumbturn option available

KEYCAP



Very few things go with us everywhere, our keys do. Keycap makes your keys look great and feel much more comfortable whether in your pocket or your hand. A wide variety of colourful caps are available, including glow in the dark options so they are easier to use at night.

Keyring brings all the benefits of Keycap with built in bluetooth. Track or activate the alarm in your keys from your phone and you'll never lose them again!

To order additional keys, please contact Ultion on 0115 784 3162.



PRESS TO FIND YOUR PHONE



PRESS TO FIND YOUR KEY

HARDWARE UPGRADES



WHY SHOULDN'T EXTREME PERSONAL PROTECTION LOOK STUNNING? WITH SWEET'S UNIQUE 'EDGELESS' DESIGN, IT ALWAYS DOES. WHETHER YOUR HOME IS CONTEMPORARY OR TRADITIONAL, COUNTRY-STYLE OR MODERN URBAN, SWEET STAYS EFFORTLESSLY COOL.

Sweet carries multiple coatings of copper and nickel, ensuring it always looks great, even after being hammered with salt water for over 5000 hours. That's an incredible 20x more times than required for the

flagship EN 1906:2012 corrosion standard. And with 4 super sleek colours to choose from, there's a sweet for everyone.



DOOR HANDLES

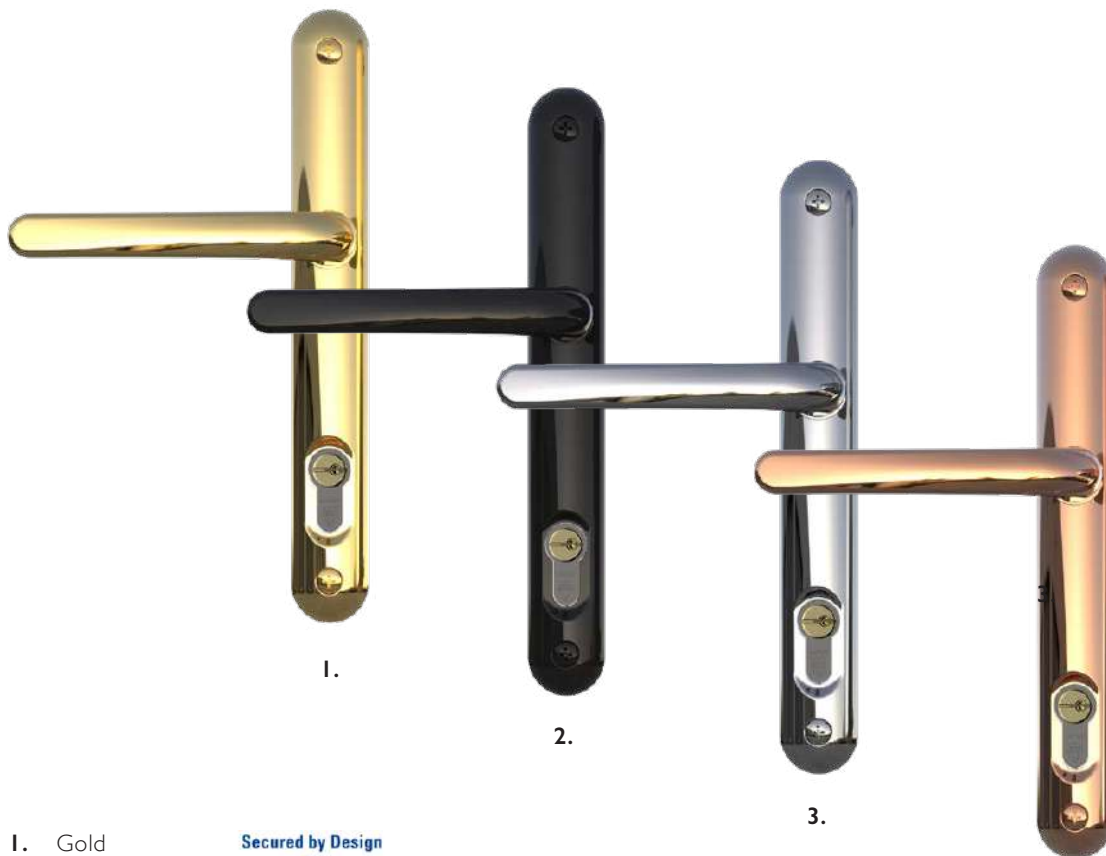

1.

2.

3.

4.

- 1. Gold
- 2. Black
- 3. Chrome
- 4. Rose Gold



HARDWARE UPGRADES

KNOCKERS



1.



2.



3.



4.

- 1. Gold
- 2. Black
- 3. Chrome
- 4. Rose Gold

ESCUTCHEONS



1.



2.



3.



4.

- 1. Gold
- 2. Black
- 3. Chrome
- 4. Rose Gold

LETTER BOX



1.



2.



3.



4.

- 1. Gold
- 2. Black
- 3. Chrome
- 4. Rose Gold

FRAME, SILL & THRESHOLD

Often it is the finishing touches to a project that make all the difference. To achieve the perfect look for your home with crucial functionality, Solar Calibre offers a choice of frame, threshold and sill options to suit your requirements.

FRAMES

STANDARD PVC-U CHAMFERED OUTERFRAME

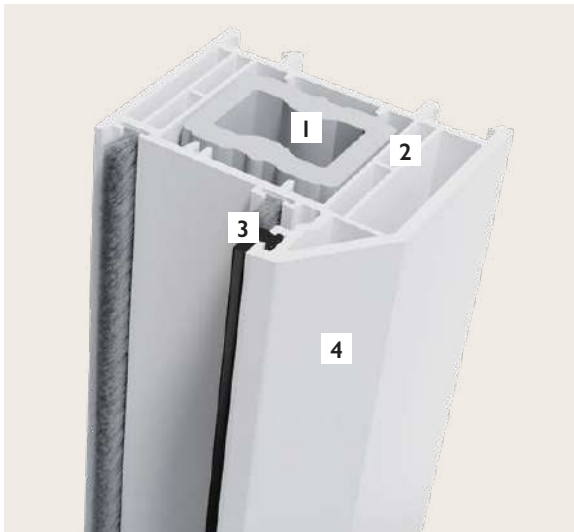

1. PTR Reinforcement
2. Multiple chambers
3. Triple seals (Gasket & woolpile seals)
4. Lead-free PVC-U

MULTI-CHAMBER PROFILE

With 8 chambers, our multi-chambered frames give an impressive thermal performance as standard

ENVIRONMENTALLY FRIENDLY FRAMES

Lead-free profile and plastic thermal reinforcements (PTRs) are both thermally efficient and incredibly strong with the added bonus of being light and quick to install

TRIPLE SEALED

Our innovative system uses three gaskets to reduce heat loss and improve weather-tightness

SECURE CONSTRUCTION

With 72% better screw retention than through steel, PTRs offer more secure fixing of hardware keeping your frame rigid, stable and secure

TIMBER CLAD ALUMINIUM OUTERFRAME

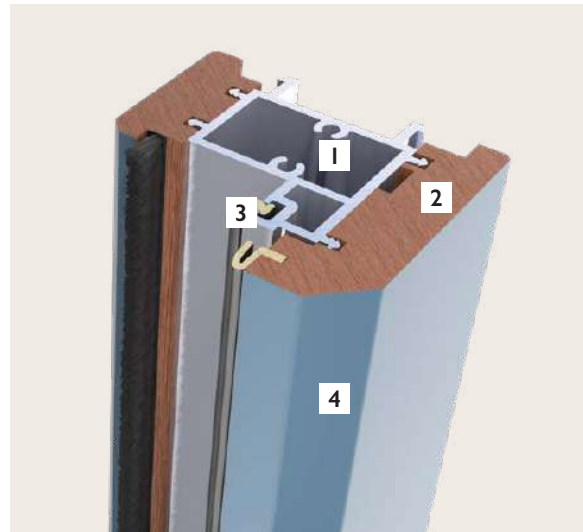

1. Rigid aluminium core
2. Sapele mahogany hardwood caps
3. Triple seals (Gasket & woolpile seals)
4. Painted to match your door colour as standard

FACTORY FINISHED PAINT TO MATCH CHOSEN DOOR COLOUR

We colour your frame as standard to seamlessly mirror your chosen door colour

TRIPLE SEALED

Our aluminium/timber system uses three gaskets to reduce heat loss and improve weather-tightness

SECURE AS STANDARD

The very construction of the timber clad aluminium frame means that the frame itself is incredibly strong and almost impossible to penetrate

SECURITY PLUS (SP) ALUMINIUM FRAME

The rigid, high security frame and its engineered construction stops warping and twisting

SILLS

TIMBER SILL



1. 94mm stub sill
2. 144mm sill
3. 174mm sill

Timber sills are available as shown or painted Black or White as standard. You may also colour match to your door and frame.

PVC-U SILL

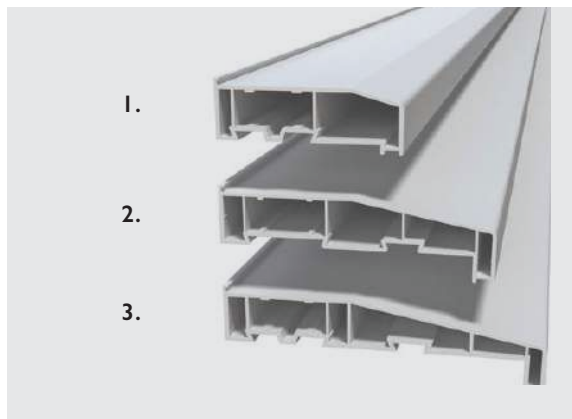

1. 100mm stub sill
2. 150mm sill
3. 180mm sill

PVC-U sills will match your PVC-U door frame as standard.

THRESHOLDS

Part M compliance aluminium door thresholds prevent rain and draughts under the door as standard

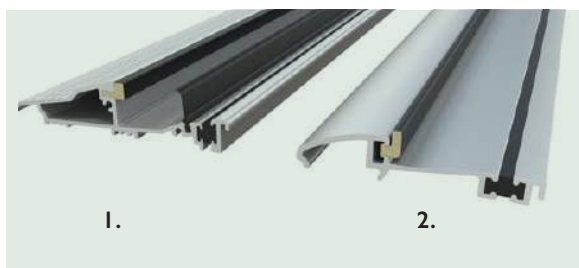

1. Stormguard AM3 aluminium threshold is Part M compliant and offers exceptional weather performance.
2. Low aluminium threshold is also Part M compliant and provides slimline appearance.

FRAME EXTENSIONS

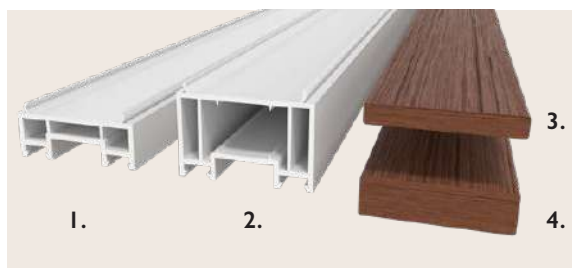

1. PVC-U 25mm
2. PVC-U 44mm
3. Timber 10mm
4. Timber 20mm

To ensure the very best fit for your Solar Calibre Craftsman door we supply a range of frame extensions in both PVC-U and hardwood options in various sizes.

CRAFTSMAN GUARANTEE

10
YEAR





1. ENGINEERED TIMBER DOOR

The unique build of the Craftsman door provides a stable, strong weatherproof construction. Guaranteed for 10 years, the Craftsman door is an investment in your home for years to come.



2. CAPPED ALUMINIUM FRAME

An incredibly strong, rigid frame, the Craftsman capped aluminium frame has a structural guarantee of 10 years, making it one of the most secure and hardworking frames on the market.



3. PVC-U DOOR FRAME

Our reinforced PVC-U frame requires little maintenance and provides a rigid frame for your Craftsman door. Whether you choose white or a woodgrain foil our frames are guaranteed for 10 years.



4. GLAZING

Our double glazed units are known for their beauty, quality and longevity. A 10 year guarantee on all our glazing units means excellent thermal performance and good looks for the future.



5. HARDWARE

Not only a matter of personal taste, our hardware range gives you choices in guarantees ranging from 5 years through to 25 years too. (See pages 59-63 for more details)



6. THRESHOLD

Whether easy access or weather protection are your deciding factors, our aluminium thresholds are guaranteed for a reassuring 5 years.

OUR GUARANTEES

- 5 Year Mechanical Guarantee
- 10 Year PVC-U Surface Guarantee
- 10 Year Foils Guarantee
- 25 Year Polished Surface Guarantee
- 5 Year Surface Finish Anodised Guarantee
- 10 Year Surface Finish Plated Guarantee
- 10 Year Structural Guarantee
- 15 Year Surface Finish Powder Coated Guarantee
- 10 Year Guarantee Against Glass Unit Failure

THERMAL AND SOLID CORE

TO MEET DOCUMENT L COMPLIANCE

Core:	44mm Door Slab				54mm Door Slab			
	Solid Core	Solid Core	Thermal Core	Thermal Core	Solid Core	Solid Core	Thermal Core	Thermal Core
Frame Type:	Timber/Alu Capped Frame	PVC-U Frame	Timber/Alu Capped Frame	PVC-U Frame	Timber/Alu Capped Frame	PVC-U Frame	Timber/Alu Capped Frame	PVC-U Frame
Albury	○	○	●	●	○	●	●	●
Arden	○	○	●	●	○	●	●	●
Ashdown	●	●	●	●	●	●	●	●
Charlcote	●	●	○	○	○	○	○	○
Charnwood	●	●	●	●	●	●	●	●
Dalby	○	○	●	●	○	●	●	●
Dean	○	○	●	●	○	●	●	●
Epping	●	●	●	●	●	●	●	●
Foxley	○	●	●	●	○	●	●	●
Galloway	○	○	●	●	○	●	●	●
Glengarry	○	○	●	●	○	●	●	●
Hampton	○	○	●	●	○	●	●	●
Hatfield	●	●	●	●	●	●	●	●
Heartwood	●	●	○	○	○	○	○	○
Highgate	○	○	●	●	○	●	●	●
Kensington	○	○	●	○	○	●	●	○
Marston	●	●	●	●	●	●	●	●
Mercia	○	○	●	●	○	●	●	●
Newstead	●	●	●	●	●	●	●	●
Parkhurst	○	○	●	●	○	●	●	●
Portland	●	●	○	○	○	○	○	○
Shackleford	○	○	●	●	○	●	●	●
Sherwood	●	●	●	●	●	●	●	●
Silverhill	○	○	●	●	○	●	●	●
Rockingham	○	○	●	●	○	●	●	●
Rufford	○	○	●	●	○	●	●	●
Wentwood	○	○	●	●	○	●	●	●
Winterfold	●	●	○	○	○	○	○	○
Whinell	●	●	○	○	○	○	○	○
Whittingham	○	○	●	●	○	●	●	●

● - Document L Compliant

○ - Unavailable

ACCREDITATIONS

SOLAR CALIBRE CONTINUALLY STRIVES FOR
- AND ACHIEVES - EXCELLENCE



The Kitemark is a UK product and service quality certification mark which is owned and operated by The British Standards Institution (BSI Group) and is achieved through rigorous testing only at a centre of excellence.



CE Marking is a mandatory conformity marking for products sold within the European Economic Area (EEA) since 1985 and is indicative of Solar Calibre's complete compliance with EU legislation.



The national body for the accreditation of testing and calibration laboratories, certification and inspection bodies, UKAS is the sole national accreditation body, of which we are a proud member.



CHAS is a health and safety accreditation scheme for the construction industry, as CHAS accredited, we are committed to annual assessments to show we are maintaining the high levels of health and safety management required.



Sold Secure Diamond is a test developed in conjunction with the Master Locksmiths Association. It is designed by locksmiths, and very few locks pass the test. Ours do.



Secured by Design focuses on crime prevention of homes and commercial premises and promotes the use of security standards for a wide range of applications and products.



ISO 14001 is an internationally agreed standard that sets out the requirements for environmental management, to improve through more efficient use of resources and reduction of waste.



PEFC Chain of Custody is the process of handling information on the origin of forest-based products and allows us to make accurate claims on the content of sustainably certified material.

CUSTOMER SUPPORT

AT SOLAR CALIBRE, OUR EXPERIENCED AND SKILLED CUSTOMER CARE TEAM IS ALWAYS ON HAND TO PROVIDE TECHNICAL ADVICE, ANSWER ANY DOOR STYLE ENQUIRIES, PROVIDE INSTALLATION ADVICE AND TO ASSIST WITH PROJECT ENQUIRIES.

We ensure that our customers have all the information they require to make the best choice and to provide excellent service.

HOW TO USE THIS BROCHURE

In designing this brochure, we aim to provide you with all the information you need in order to choose the perfect door solution. At your finger tips, you have detailed product information, photographs, hardware choices, quality guarantees and glazing options.

HOW TO PURCHASE A CRAFTSMAN DOOR

The Craftsman Door is widely available via our network of installers across the country. Please call or email us and we will be able to put you in touch with your nearest stockist.

Phone : **01623 275030**

Email : sales@solarcalibre.co.uk

FOR TRADE CUSTOMERS ONLY

To place your order with us, you can do it in one of three ways:

Phone : **01623 275030**

Email : sales@solarcalibre.co.uk

Online : doors.solarcalibre.co.uk

Be sure to have your account number handy when making your order, so we can find your business details quickly on our system.



YOU CAN TRUST US TO DELIVER

We measure our success in accurately providing what you ordered, quickly and on time. We ensure our stock levels are kept continuously high meaning you don't have to. Remember: keep us informed if you are planning a large project and we will make sure we have everything you need in stock.

WE HAVE THE TECHNICAL KNOW-HOW

Unsure what door or hardware would be best for a specific job? Our team has specialist working knowledge of our product range, give them a call for helpful technical advice and support.

DISCOVER MORE FROM SOLAR CALIBRE DOORS



BENCHMARK

A style to suit every home.

Using only the best quality components, Benchmark doors are designed and manufactured without compromise.

With a range of styles, from country cottage and Edwardian townhouse to more contemporary offerings, you can be sure to find the perfect door for your home.

For more on Benchmark, visit:
solarcalibrenorvik.com/benchmark



WARDEN

Fire doors without compromise.

The Warden range was developed with a focus on ensuring exemplary performance and constantly exceeding the standards expected.

Fully furnace tested on both sides, as well as smoke tested to European standards, each door type has been stringently tested to ensure consistency of performance.

For more on Warden, visit:
solarcalibrenorvik.com/warden



PORTIUM

Thermal efficiency at its core.

Portium timber front doors are designed with both beauty and function in mind.

With a range of contemporary and traditional finishes in a wide range of colours, Portium ensures you can bring your vision to life without compromising on quality.

For more on Portium, call us on:
01623 275030



The Solar Group of companies includes:

Solar Calibre Doors Ltd (12606317)
Solar Windows Ltd (02678809)
Solar Norvik Ltd (12610230)
Fire Doors by Solar Ltd (11670160)

